

LASTING ELEGANCE

ENTRY DOORS 2024



HMI ADVANTAGE

HMI is the one-stop-shop for your entryway needs. Whether it's our Entry Doors, Aluminum Storm Doors or Security Storm Doors. Our advanced production facilities make HMI one of the few companies that manufacture doors according to customer specifications. We are a make-to-order company treating each door as a custom order, whether it is standard size or not.

Lasting Elegance Steel, Regency & Aspen Fiberglass Entry Doors

HMI's entry doors are designed to the highest standards of energy efficiency, security, and rigidity without sacrificing beauty. They are available in either *steel* or *fiberglass*. Made to enhance your entryway and satisfy the unique taste of each homeowner, we offer a variety of rich colors with a comprehensive collection of decorative glass.

We offer the most secure entry doors on the market. Our steel doors have a 19" lock block with a 14 gauge steel reinforcement channel. Whether it is smooth or textured steel, the HMI steel door, is equipped with 20 gauge galvanealed steel. Our Aspen fiberglass collection boasts a 4" lock side stile with a 7 gauge steel plate embedded the entire length of the door.

To deter rotting, the top and bottom rails inside of our entry doors are composite and for optimal insulation our doors are injected with high density polyurethane foam filling every nook and cranny.

The vinyl thermal break on our steel doors also improves energy efficiency by controlling heat transfer. Thermally broken metal doors are insulated against heat and cold conduction. This is done by separating the outside metal from the inside with a non-conductive material (vinyl).

We set the industry standard for custom, top of the line entry doors. With over 80 door styles, 36 paint colors, 15 different glass families, 10 stain finishes, 5 custom arch top profiles, and the ability to fabricate doors in 1/4" increments to fit in either a new construction or replacement frame opening, there is no need to look elsewhere for your entrance way needs.

Whether you choose a steel or fiberglass door, HMI exceeds your expectations of security, energy, efficiency and beauty.



PROUDLY MADE IN THE U.S.A.

Cover Photo: HM 242LON Door and HS 242LON Sidelites

There's no place like home. — Dorothy, Wizard of Oz

At HMI Doors we recognize your home is a unique, comforting safe haven in which you take pride.

Let us help you set that tone showing your uniqueness at the very place it all begins...your front door.

- | | | | |
|-----------|-------------------------------------|-----------|--|
| 4 | LASTING ELEGANCE STEEL DOORS | 38 | LIBERTY / INDEPENDENCE - LB |
| 5 | JAMBS, CAPPING & REPLACEMENT FRAMES | 39 | OAK PARK - KP |
| 6 | REGENCY FIBERGLASS COLLECTION | 40 | SYLVAN PARK - PRK |
| 7 | ASPEN FIBERGLASS COLLECTION | 42 | RENEWED IMPRESSIONS - LRI |
| 8 | CONTEMPORARY FIBERGLASS COLLECTION | 44 | EMBASSY - Y, YS |
| 10 | CRAFTSMAN FIBERGLASS COLLECTION | 46 | TAJ - K, KS |
| 11 | SPEAKEASY DOOR COLLECTION | 48 | BLOSSOM - BL |
| 12 | MODA COLLECTION (CONTEMPORARY) | 50 | GRACE - GRC |
| 14 | CAPE COD | 52 | LAUREL - LRS |
| 15 | SHAKER DOORS | 54 | FANLITE / CAMBER TOP GLASS |
| 16 | 96" FIBERGLASS COLLECTION | 55 | CRAFTSMAN / ARTISAN GLASS |
| 18 | SIMULATED DIVIDED LITES | 56 | PHOTO GALLERY |
| 20 | SLIDING DOOR COLLECTION | 58 | HM 200 SERIES - ONE LITE GLASS / VENTLITES |
| 22 | LONDON - LON | 60 | HM 200 SERIES - NO GLASS |
| 24 | CHANELLE - CH | 61 | HM 300 SERIES - EXTERNAL GRIDS |
| 26 | ZENITH - ZE | 62 | HM 400 SERIES - INTERNAL GRIDS |
| 27 | LINEN - LIN | 63 | HM 500 SERIES - INTERNAL STEEL GRIDS |
| 28 | LAFAYETTE - LA | 64 | INTERNAL MINI BLINDS |
| 29 | VALENCIA - VA | 65 | CUSTOM DOOR CONFIGURATIONS |
| 30 | ROME - RO | 66 | FIRE RATED / BULLET RESISTANT DOOR PANELS |
| 31 | FLORENCE - FL | 67 | FRENCH SIDELITES & QUICKSHIP |
| 32 | COURTYARD - CTD | 68 | HARDWARE |
| 33 | ASHBURY - ASH | 70 | 3-POINT LOCK |
| 34 | HEIRLOOM - N, NS | 71 | PAINT, POWDERCOAT & STAINS |
| 36 | NOUVEAU - AS, AP | | |

CAMING KEY

- PATINA / BLACK / WROUGHT IRON
- POLISH BRASS ● ANTIQUE BRASS
- SATIN NICKEL / PLATINUM

Ⓢ Available in Severe Weather Glass

* Due to lighting variations, glass may look different than the images depicted in this brochure.



LASTING ELEGANCE STEEL DOORS

- All HMI steel doors are 20 gauge enhancing their security.
- Available in smooth and textured steel.
- The rolled steel door edges with a vinyl thermal break, the full length of the perimeter, prevents heat transfer.
- Composite rail at the top and bottom deter rotting.
- Injected polyurethane foam insulation fills every nook and cranny inside the door giving it optimal insulation.
- The 19" wood lock block with 14 gauge steel reinforcement U-Channel wards off break-ins at the lock location.



▼ HME 246 Door

20 Gauge Steel door panels available in Smooth or Textured Surface

Injected High Density Polyurethane Insulating Foam

19" Security Lock Block with 14 Gauge Steel Reinforcement Channel



SMOOTH STEEL

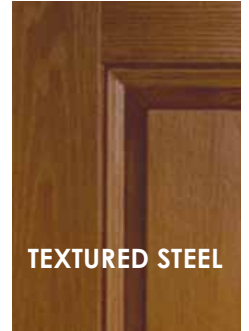

TEXTURED STEEL

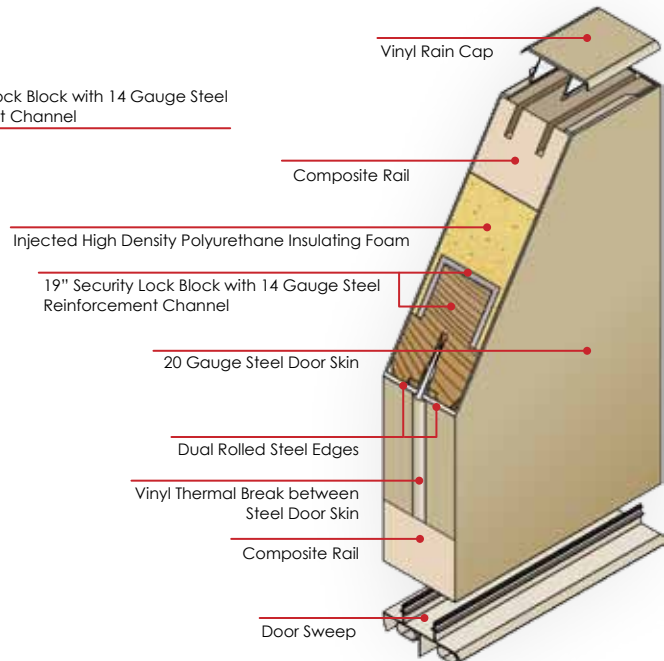

Magnetic Weather-strip for positive air seal along the header and lock side



Q-Lon Weather-strip for compression weather seal along hinge side

INSWING AND OUTSWING THRESHOLDS

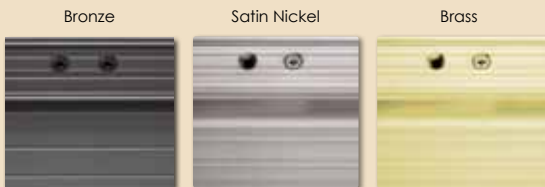

Bronze

Satin Nickel

Brass

Adjust & Lock Threshold with Thermal Break



Outswing Sill



Composite bottom rot proof, energy efficient



Inswing Sill

JAMBS, CAPPING & REPLACEMENT FRAMES

STEEL REPLACEMENT FRAME

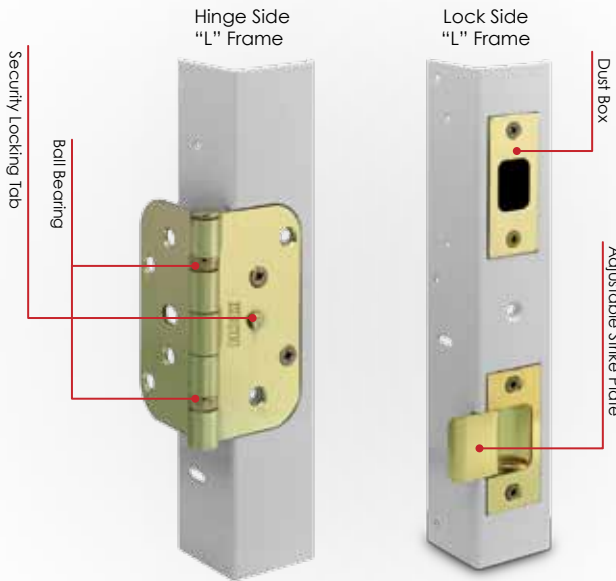

Steel Replacement Frames are constructed of 18 gauge galvanized steel with 10 gauge plates located on the lock and hinge sides for extra reinforcement to help keep intruders out. White is standard.

Steel replacement frames are utilized when removal of the existing jamb is not practical. It allows for a new door to be adapted into an existing jamb, providing new hinge & strike plates while hiding the old hinge and strike cut-outs.



PRIMED WOOD JAMB - Standard

4 ⁹/₁₆ Prime Wood Jamb STD

Optional: 5 ¹/₄, 6 ⁹/₁₆ and custom sizes up to 12"

Painted or stained aluminum cladding to match interior and exterior of the door.

ALUMINUM CLADDING - Optional

.028 Thick aluminum cladding prolongs the life of your HMI door unit.

Available in both smooth and wood grain texture.



ARMORMAX JAMB™ - Optional

Patented

Replacement entry doors emerged during the 1970's. The steel "L" frame shored up the jamb giving it the security that homeowners desired. The ArmorMax Jamb™ System replicates that security in a pre-hung door by having an 18 gauge steel "L" frame embedded in the jamb on the lock side. And if needed hinge side.

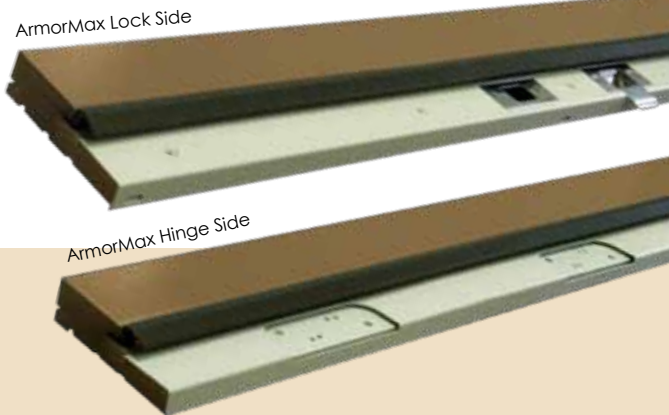

INTERIOR CASING

Interior casing can be painted or stained; or come unfinished for customer to finish.

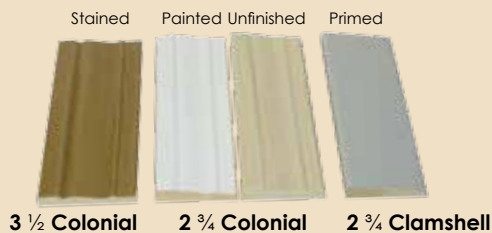

Anti-Pry Ball Bearing Hinges
Available in Black, Aged Bronze, Satin Nickel, Polished and Antique Brass.

REGENCY FIBERGLASS COLLECTION

Regency doors manufactured by HMI set the standard for beauty, quality and performance at excellent value. Explore the innovation and craftsmanship of door design for long lasting efficiency and durability.



- A** Composite top and bottom rail to help prevent moisture wicking from bottom of door.
- B** 20" lock block to enhance the durability.
- C** 2 1/4" engineered lumber stiles on lock and hinge side for rigidity and stability.
- D** Injected with polyurethane foam to offer 4 times the insulating value of wood.
- E** The durability of fiberglass to provide years of hassle-free, low maintenance - which unlike wood, does not warp or rot.
- F** Unlike steel doors which pose the risk of dents and/or rust, fiberglass skins provide more resiliency to stand up to normal wear and tear.



Oak Grain



Mahogany Grain



Fir Grain

ASPEN FIBERGLASS COLLECTION

Aspen doors manufactured by HMI set the standard for beauty, quality and performance at excellent value. Explore the innovation and craftsmanship of door design for long lasting efficiency and durability.



- A** Composite top and bottom rail to help block the moisture that can wick the door.
- B** 4" lock stile with **C** 1"x1/4" steel reinforcement the entire height of door enhance the durability.
- D** 2 1/4" engineered lumber stiles on hinge side for rigidity and stability.
- E** Built with polyurethane foam core that offers 4 times of insulating R-value of wood HMI fiberglass doors insulate against heat and cold for energy efficiency.
- F** Fiberglass durability with little maintenance. The fiberglass door will bring years of durability. Unlike wood doors, fiberglass will not warp or rot and unlike steel doors will not dent or rust.
- G** Armormax lock side door frame included in Aspen door package for additional protection against intruders, and hinge side frame optional.

ASPEN - LOCK SIDE STILE™ Patented

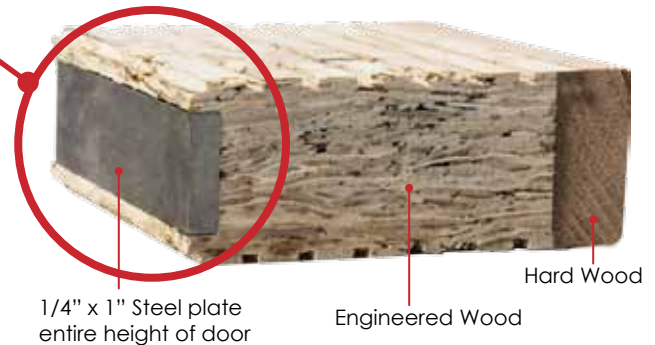

ARMORMAX JAMB™

Replacement entry doors emerged during the 1970's. The steel "L" frame shored up the jamb giving it the security that homeowners desired. The ArmorMax Jamb™ System replicates that security in a pre-hung door by having an 18 gauge steel "L" frame embedded in the jamb on the lock side.



Cherry Grain

Select Fiberglass Door Styles Are Available In All Grains

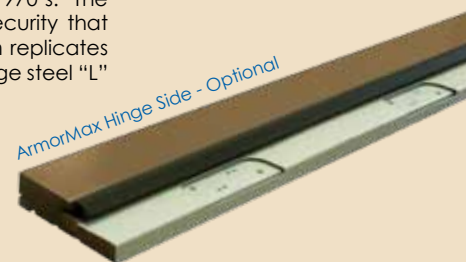

CONTEMPORARY FIBERGLASS COLLECTION

Simple yet sophisticated clean lines give you the contemporary look that you want. Available in cherry grain fiberglass these doors can be made to Regency or Aspen specs.

HM 87 Door and HS 200 Sidelites ▼



Cherry Grain



HM 86

PRIVACY RATING
7

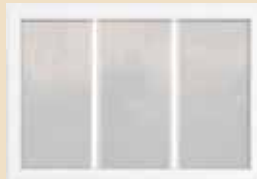

HM 86-3L

PRIVACY RATING
9



HM 86-6L

PRIVACY RATING
9



● HM 86LRS



● HM 86TPZ

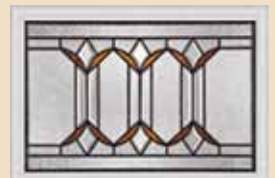

● HM 86PRK



HM 87 ▲



CA 1, 2, 3, 4, 5

HM 88



CA 1, 2, 3, 4, 5

HM 89

HM 88 Circle Top Door ▼



HM 86TPZ Door and HS 86TPZ Sidelites ▼



Circle Top
CA 1

Camber Top
CA 2

Curved Top
CA 3

Pointed Top
CA 4

Cathedral Top
CA 5











HS 84



HS 42



No External Trim

									
Max Size 40 x 96	86	86-3L	86-6L	87	88	89	84	86	42
Price Book Page	38	38	38	38	38	38	38	38	38
Fiberglass									
Regency & Aspen Cherry	96"	96"	96"	96"	96"	96"	96"	96"	96"
Regency & Aspen Smooth									
Micro-Granite - MG	•	•	•				•	•	•
Rain - RN	•	•	•				•	•	•

CRAFTSMAN FIBERGLASS COLLECTION



HME 386-6L Door and HSE 386 Sidelites ▲



HME 285 HME 385-3L HME 385-6L HME 286 HME 386-3L



Optional Dentil Shelf



HME 386-6L HS 242 ● HS 242LRS ● HS 242TPZ ● HS 242PRK HSE 286

PRIVACY RATING

7

PRIVACY RATING

9

PRIVACY RATING

9



● HME 285LRS pg. 70
● HME 286LRS pg. 66

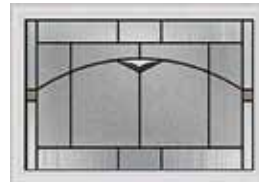

● HME 285TPZ pg. 70
● HME 286TPZ pg. 66

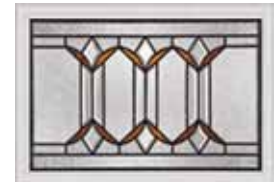

● HME 285PRK pg. 70
● HME 286PRK pg. 66

For internal steel grids matching door color see page 63 - 500 Series Doors

	285	385-3L	385-6L	286	386-3L	386-6L	242	286
Price Book Page	70	70	70	66	66	66	72	80

Fiberglass

Regency & Aspen Oak	84"	84"	84"				84"	
Regency & Aspen Cherry	84"	84"	84"				84"	
Regency & Aspen Fir				84"	84"	84"		84"
Regency & Aspen Smooth				84"	84"	84"	84"	
Micro-Granite - MG	•	•	•	•	•	•	•	•
Rain - RN	•	•	•	•	•	•	•	•
Streamed - STM	•	•		•	•		•	
Geo-Tex - GTX	•			•			•	



Cherry Grain



Fir Grain



Smooth Grain

SPEAKEASY COLLECTION

HME 295 Door with Optional Speakeasy and Clavos ▼



Speakeasy door grilles are reminiscent of the days of prohibition and Al Capone. They embody that feeling of intrigue and are a special focal point for any entryway.

- Hand forged steel grille – 11 ½ " W X 15 ½ "H
- 1" insulated glass (stationary) – 6"W X 8"H
- Hinged interior door with easy to use latch
- Finished with matte finish black powder coating
- Optional 1 ¼ " Clavos (buttons)

With Clavos

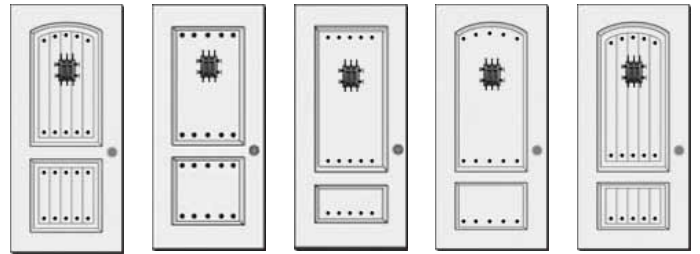

HME 246SPC HME 252SPC HME 273SPC HME 295SPC HME 296SPC

Without Clavos

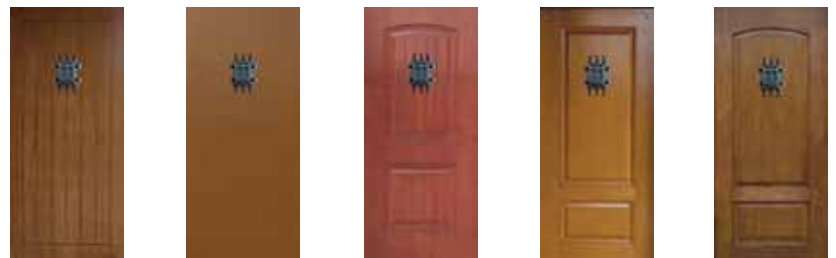

HM 88SP HM 202SP HME 246SP HME 273SP HME 295SP



Outside Closed



Inside Opened 1" Insulated Glass



HME 296SP



Inside Closed



Clavos

	88	202	246	252	273	295	296
--	----	-----	-----	-----	-----	-----	-----

Price Book Page	39	39	39	39	39	39	39
------------------------	----	----	----	----	----	----	----

Steel

Smooth Steel 20GU		96"	84"	84"	84"		
Textured Steel 20GU		96"	84"	84"	84"		

Fiberglass

Regency & Aspen Oak		84"	80"	80"	84"		
Regency & Aspen Cherry	84"	84"			84"	84"	84"
Regency & Aspen Smooth		84"			84"		

Progress is Endless

Our Moda Doors are contemporary with a retro influence. The flush aluminum glass trim gives a sleek look to the design. The simple yet sophisticated styles reflect your fashion sense – Clean lines, Crisp look, Contemporary living – just what you were looking for.



HM 95 and HS 200



HM 94



HM 98

Don't let the entranceway size of your remodeling project limit you to available style selections offered by HMI Doors. With the Model Panel, customers are able to recreate the look of an embossed door or sidelite, while empowering homeowners with the ability to choose different accent colors for their Moda Trim or Pane;. Make the choice to liven up the finished look of your entranceway, and really give your HMI Doors some character!

Moda Panel Construction

High Heat Resistant

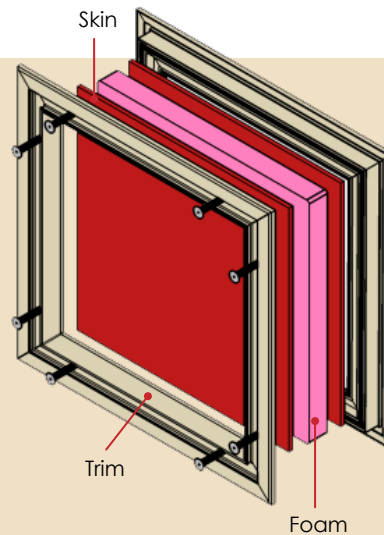

HM 90



HM 96RN and HS 200RN
You can enjoy max visible glass
with min. 3 1/2" door rail

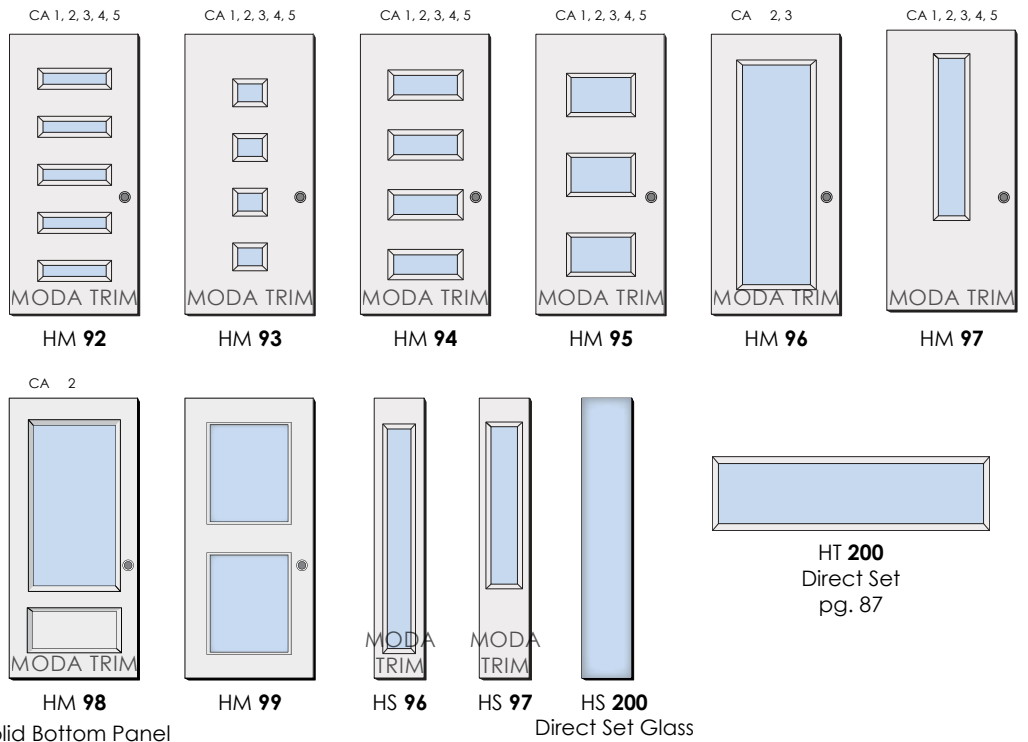

Solid Bottom Panel
with Moda Trim

Direct Set Glass

TRIM

Extruded Aluminum Flush
Trim High Heat Resistant

No Exposed Screw Plugs



Exterior



Interior

Don't let the entranceway size of your remodeling project limit you to the available style selections offered by HMI Doors. With the Moda Panel, customers are able to recreate the look of an embossed door or sidelite, while empowering homeowners with the ability to choose different accent colors for their Moda Trim or Panel. Make the choice to liven up the finished look of your entranceway, and really give your HMI Door some character!



HM 92

Moda Glass Door Styles	92	93	94	95	96	97	98	99	96	97	200
Price Book Page	40	40	40	40	40	40	40	40	41	41	71
Steel											
Smooth Steel 20GU	96"	96"	96"	96"	96"	96"	96"	96"	96"	96"	
Textured Steel 20GU	96"	96"	96"	96"	96"	96"	96"	96"	96"	84"	
Fiberglass											
Regency & Aspen Oak	84"	84"	84"	84"	84"	84"	84"	80"	84"	84"	
Regency & Aspen Cherry	96"	96"	96"	96"	96"	96"	96"	96"	84"	84"	84"
Regency & Aspen Smooth	96"	96"	96"	96"	96"	96"	84"	96"			
Micro-Granite - MG	•	•	•	•	•	•	•	•	•	•	•
Rain - RN	•	•	•	•	•	•	•	•	•	•	•

GLASS OPTIONS



Clear



Rain



Micro-Granite - MG
(Old Pebbled)



Blanca

HM 80 Door ▼

HM 82 Door External Grids ▼



HM 80



HM 81



HM 82



HM 83

Max Size 40 x 96	80	81	82	83
Price Book Page	67	67	67	67
Fiberglass				
Regency & Aspen Cherry	96	96	96	96
Regency & Aspen Smooth	96	96	96	96
Micro-Granite - MG	•	•	•	•

- Available only in cherry fiberglass only
- Clear or micro-granite glass

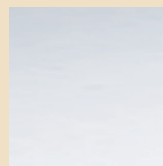

Clear



Micro-Granite - MG
(Old Pebbled)

SHAKER DOORS

HM 77 Door and HS 200 Sidelites ▼



HM 70 HS 70 HM 71 HS 71 HM 72 HS 72

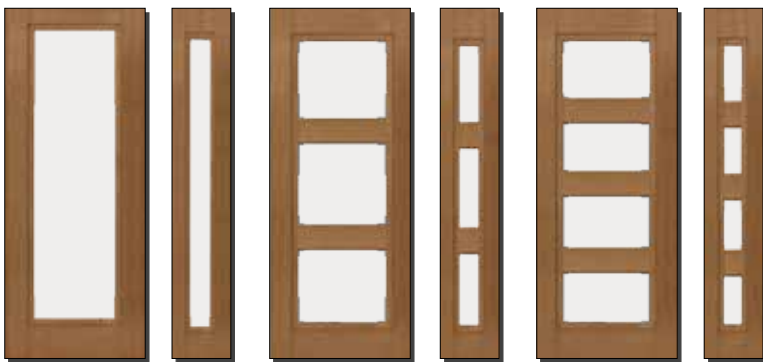

HM 73 HS 73 HM 74 HS 74 HM 75 HS 75



HM 76 HS 76 HM 77 HS 77

Fir Grain



Max Size 36 x 84	70	71	72	73	74	75	76	77	70	71	72	73	74	75	76	77
Price Book Page	67	67	67	67	67	67	67	67	81	81	81	81	81	81	81	81
Fiberglass																
Aspen Fir	84	84	84	84	84	84	84	84	84	84	84	84	84	84	84	84
Regency Fir	84	84	84	84	84	84	84	84	84	84	84	84	84	84	84	84
Micro-Granite - MG			•	•	•	•	•	•			•	•	•	•	•	•
Rain - RN			•	•	•	•	•	•			•	•	•	•	•	•

96" FIBERGLASS COLLECTION



CA 1, 2, 3, 4, 5 CA 2, 3 CA 2, 3 CA 2, 3 CA 2, 3 CA 2, 3 CA 2, 3 CA 2, 3

HM 202-8 HM 242-8 22 x 80 HME 274-8 22 x 64 HME 375-8-6SDL 22 x 64 HME 375-8-8SDL 22 x 64 HME 375-8-15SDL 22 x 64 HME 295-8 HME 296-8



FLORENCE FL HAMILTON HA LAFAYETTE LA VALENCIA VA ASHBURY ● ASH GRACE ● GRC / ● GRC-P TAJ ● K / ● KS LAUREL ● LRS

Max Size 36 x 96	242-8	274-8	279-8	242-8	295-8
Price Book Page	34	60	64	74	75
Fiberglass	22x80	22x64	22x64	8x80	8x64
Aspen Cherry	96"	96"	96"	96"	96"
Valencia - VA *	•	•	•	•	•
Hamilton - HA *	•	•	•	•	•
Florence - FL *	•	•	•	•	•
Lafayette - LA *	•	•	•	•	•
Ashbury - ASH	•	•	•	•	•
Heirloom - N/NS	•	•	•	•	•
Impressions - LI	•	•	•	•	•
Sylvan Park - PRK	N/A	•	•	N/A	•
Embassy - Y/YS	•	•	•	•	•
Taj - K/KS	•	•	•	•	•
Grace - GRC/GRC-P	•	•	•	•	•
Laurel - LRS	N/A	•	•	N/A	•

ASPEN - LOCK SIDE STILE™ Patented

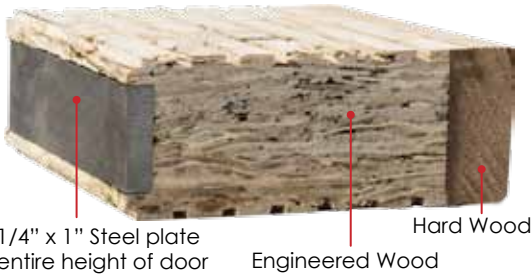

See pages 21-48 for more information on each glass style

CAMING KEY

- PATINA / BLACK / WROUGHT IRON
- POLISH BRASS ● ANTIQUE BRASS
- SATIN NICKEL / PLATINUM

* Micro-Granite - MG Glass is standard for these glass styles (VA, HA, DU, TU, FL, LA)

96" FIBERGLASS COLLECTION

HME 375-8-8SDL Door and HSE 375-8-5SDL Sidelites ▼



HS 242-8 8 x 80 HSE 375-8-3SDL 8 x 64 HSE 375-8-4SDL 8 x 64 HSE 375-8-5SDL 8 x 64 HSE 295-8 8 x 64



Available Only
With 3 Point Lock



HEIRLOOM
● N / ● NS



SYLVAN PARK
● PRK



EMBASSY
● Y / ● YS

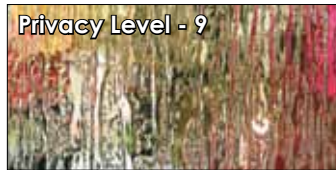

Rain - RN Optional



Micro-Granite - MG Optional
(Old Pebbled)



Streamed - STM



Allegro #44













Capri #45



Berkeley #47



										
Max Size 36 x 96	202-8	242-8	274-8	279-8	295-8	296-8	375-8	242-8	295-8	375-8
Price Book Page	26	34	60	64	65	65	61	74	75	75
Fiberglass										
Aspen Cherry	96"	96"	96"	96"	96"	96"	96"	96"	96"	96"
Micro-Granite - MG		•	•	•				•	•	
Rain - RN		•	•	•					•	
Streamed - STM		•	•	•				•	•	
Geo-Tex - GTX		•	•	•				•	•	

SIMULATED DIVIDED LITES COLLECTION



HME 351-SDL Door ▲



HME 319-SDL



HME 321-SDL



HME 322-SDL



HSE 319-SDL



HSE 321-SDL



Simulated Divided Lite Door Styles	319	321	322	319	321
Price Book Page	36	36	36	37	37
Steel					
Smooth Steel 20GU	84"	84"	96"	96"	84"
Textured Steel 20GU	84"	84"	96"	96"	84"
Fiberglass					
Regency & Aspen Oak	84"	84"	84"	84"	84"
Regency & Aspen Cherry	84"	84"	84"	84"	84"
Regency & Aspen Mahogany	84"	84"	84"	84"	84"
Regency & Aspen Smooth	80"	84"	84"	84"	84"

For custom size SDL glass aluminum moda trim with external aluminum grid matches door color and heat resistant.

Clear Glass Standard



Micro-Granite - MG Optional (Old Pebbled)

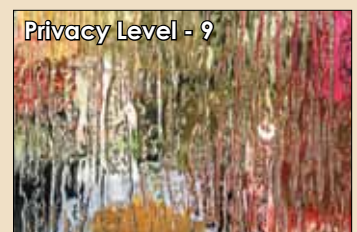

Rain - RN Optional

SIMULATED DIVIDED LITES COLLECTION



HM 348-SDL Door, HS 348-SDL Sidelites and HT 230 Transom ▲

Clear Glass Standard



HM 348-SDL HME 350-SDL HME 351-SDL HME 352-SDL HME 353-SDL



HME 354-SDL HME 355-SDL HME 356-SDL HM 358-SDL HM 360-SDL



HS 348-SDL HSE 350-SDL HSE 352-SDL HSE 354-SDL HSE 356-SDL

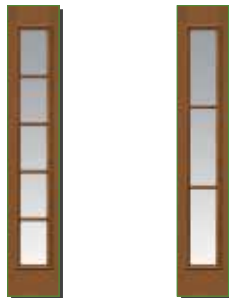

HS 358-SDL HS 360-SDL



For custom size SDL glass aluminum moda trim with external aluminum grid matches door color and heat resistant.

Simulated Divided Lite Door Styles	348	350	351	352	353	354	355	356	358	360	348	350	352	354	356	358	360
Price Book Page	35	35	35	35	35	35	35	35	35	35	36	36	36	36	36	36	36
Steel																	
Smooth Steel 20GU	96"	84"	84"	84"	84"	84"	84"	84"	96"	96"	96"	84"	84"	84"	96"	96"	96"
Textured Steel 20GU	96"	84"	84"	84"	84"	84"	84"	84"	96"	96"	96"	84"	84"	84"	96"	96"	96"
Fiberglass																	
Regency & Aspen Oak	84"	84"	84"	84"	84"	84"	84"	84"	84"	84"	84"	84"	84"	84"	84"	84"	84"
Regency & Aspen Cherry	84"	84"	84"	84"	84"	84"	84"	84"	84"	84"	84"	84"	84"	84"	84"	84"	84"
Regency & Aspen Mahogany	84"	84"		84"		84"		84"	84"	84"	84"	84"	84"	84"	84"	84"	84"
Regency & Aspen Smooth	84"	80"	84"	80"	84"	80"	84"	80"	84"	84"	84"	84"	84"	84"	84"	84"	84"

SLIDING DOORS COLLECTION

AVAILABLE ONLY IN SMOOTH, OAK & CHERRY FIBERGLASS

HM 219 Doors ▼



Auxiliary Latch

Single Door Operates With Pet Door on Active Door Only

HM 345 Doors ▼



Pocket Handle Outside

Both Doors Operate With Single Screen

Fiberglass	Oak & Smooth	Cherry Grain
2 Panel Slide Min Unit Size	48 x 74	48 x 74
2 Panel Slide Max Unit Size	70 x 85	82 x 85
3 Panel Slide Min Unit Size	66 x 74	123 x 85
3 Panel Slide Max Unit Size	66 x 74	123 x 85
4 Panel Slide Min Unit Size	88 x 74	88 x 74
4 Panel Slide Max Unit Size	139 x 85	162 x 85

STD Glass Size 20/22 x 64

Price Book Page 18

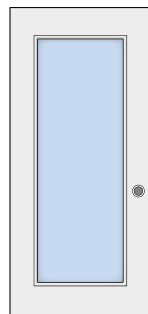

HM 242

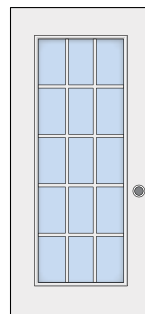

HM 409

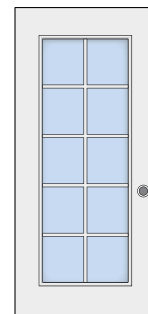

HM 411

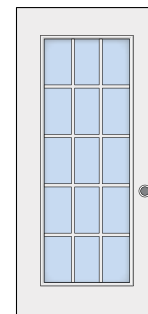

HM 509

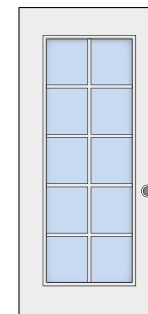

HM 511



Used for double operating doors SL-3

Interior Exterior

■ ■ ■ #60



■ ■ ■ #62



■ ■ ■ ■ ■ #64



■ ■ ■ ■ ■ #66



Jamb Side Latch



Auxiliary Latch on Active Doors

■ Polished Brass

■ Satin Nickel

■ Aged Bronze

■ White

■ Black

SLIDING DOORS COLLECTION

AVAILABLE ONLY IN SMOOTH, OAK & CHERRY FIBERGLASS

HM 242 Doors ▼

HM 409 Doors ▼



Single Door Operates With Single Screen

Both Doors Operate With Dual Screen

The ergonomically placed single* operator lets you tilt, raise and lower your blinds the entire length of the doorglass with only the slightest movement. No reaching or stooping is needed to adjust the blinds.



* Due to the size and weight of the blinds, the 80" sizes have a dual operator that controls the raise, lower and tilt function.

BLIND COLORS

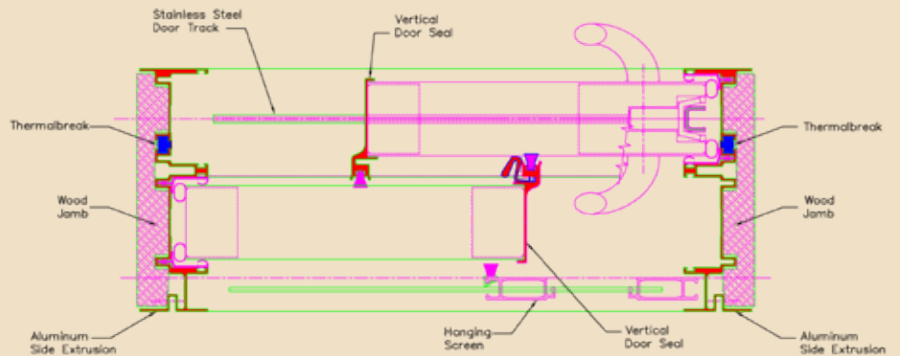
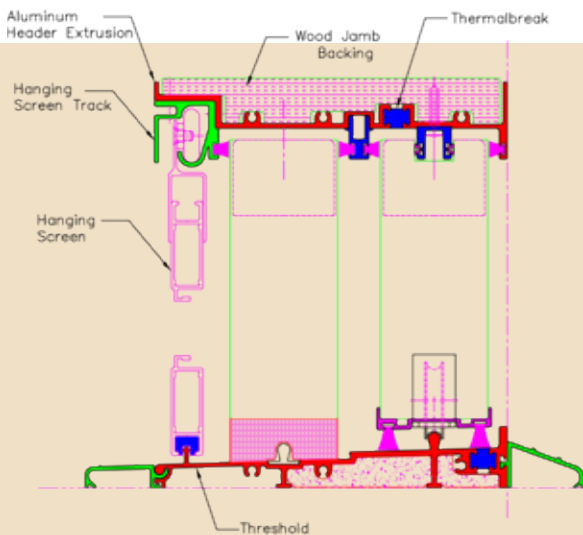
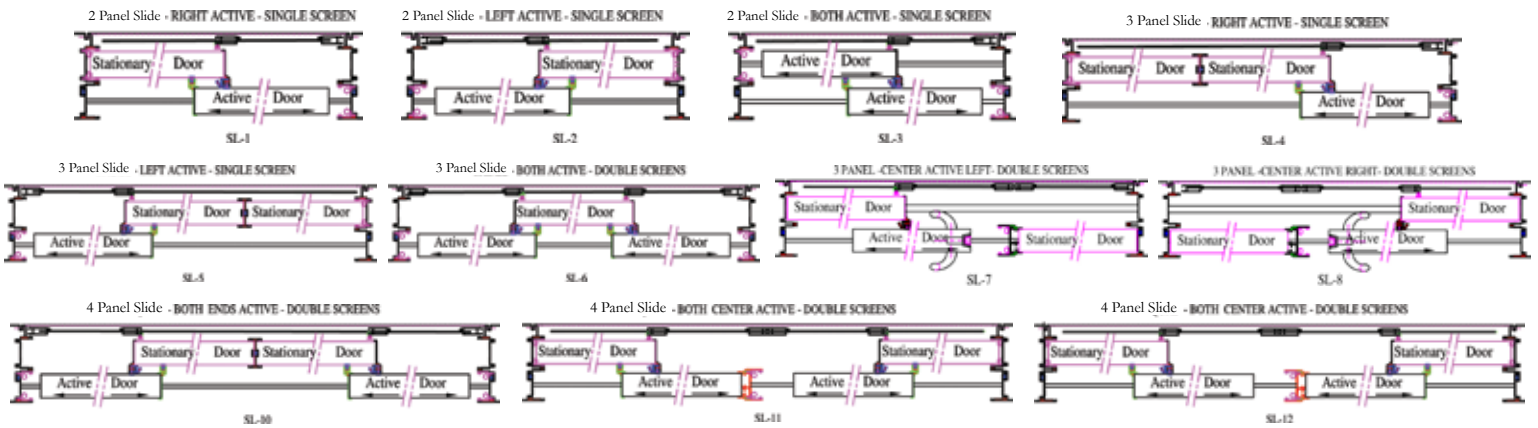
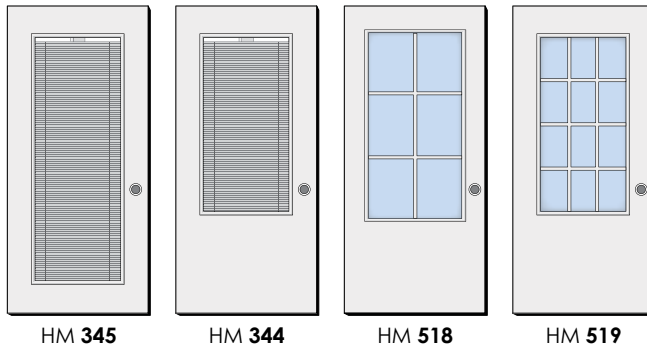

LONDON

by Western Reflections

● HM 242-LON Door and ● HS 242-LON Sidelites ▼



Caming Available

● Patina (black)

Privacy Level

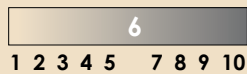

STD Trim



- Standard Trim with Factory Installed Screw Plugs (inside of the house)

MODA Trim



- Optional
- Made of extruded aluminum
- No Screw Plugs
- Ideal for dark doors behind storm doors

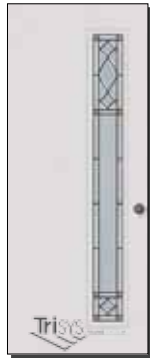

● HM 212-LON



● HME 223-LON

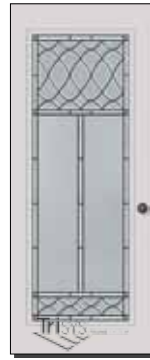

● HM 242-LON



● HME 268-LON



● HME 274-LON



● HME 279-LON



● HS 242-LON

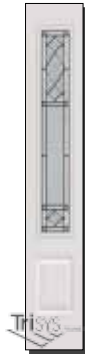









● HSE 268-LON



● HT 200-LON
pg. 91

London Glass
Door Styles

								
Price Book Page	28	21	31	56	58	62	72	78
Steel								
Smooth Steel 20GU	96"	96"	96"	96"	84"		96"	96"
Textured Steel 20GU	96"	96"	96"	96"	84"		96"	96"
Fiberglass								
Regency & Aspen Oak	84"	84"	84"	84"	84"		84"	84"
Regency & Aspen Cherry	84"	84"	84"	84"	84"	84"	96"	84"
Regency & Aspen Mahogany		84"	84"	84"			84"	84"
Regency & Aspen Fir							84'	
Regency & Aspen Smooth	84"	80"	84"	80"	84"		84"	84"

CHANELLE

by RSL

● HME 274-CH Door and ● HSE 268-CH Sidelites ▼



Privacy Level

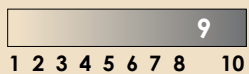

STD Trim



- Standard Trim with Factory Installed Screw Plugs (inside of the house)

MODA Trim



- Optional
- Made of extruded aluminum
- No Screw Plugs
- Ideal for dark doors behind storm doors



Chanelle Glass Door Styles

	210	212	216	224	230	242	248	254	263	268	272	274	279	224	242	268
Price Book Page	27	28	46	44	48	31	50	52	54	56	49	58	62	76	72	78
Steel																
Smooth Steel 20GU	96"	96"	96"	96"	84"	96"	84"	84"	84"	96"	84"	84"		96"	96"	96"
Textured Steel 20GU	96"	96"	96"	96"	84"	96"	84"	84"	84"	96"	84"	84"		96"	96"	96"
Fiberglass																
Regency & Aspen Oak	84"	84"	84"	84"		84"	80"	80"	84"	84"		84"		84"	84"	84"
Regency & Aspen Cherry	84"	84"	84"	84"		84"			84"	84"		84"	84"	84"	96"	84"
Regency & Aspen Mahogany				84"		84"			84"	84"				84"	84"	84"
Regency & Aspen Fir															84"	
Regency & Aspen Smooth	84"	84"	84"	80"	80"	84"				80"		84"		80"	84"	84"

ZENITH

by RSL



HM 242-ZE Door and HS 242-ZE Sidelites ▲



● HM 212-ZE



● HME 224-ZE



● HM 242-ZE



● HME 254-ZE



● HME 268-ZE



● HME 274-ZE



● HME 279-ZE



● HSE 224-ZE



● HS 242-ZE



● HSE 268-ZE

MODA Trim



- Optional
- Made of extruded aluminum
- No Screw Plugs
- Ideal for dark doors behind storm doors

STD Trim



- Standard Trim with Factory Installed Screw Plugs (inside of the house)

Privacy Level

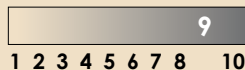

Zenith Glass Door Styles

	212	224	242	254	268	274	279	224	242	268
Price Book Page	28	44	31	52	56	58	62	76	72	78
Steel										
Smooth Steel 20GU	96"	96"	96"	84"	96"	84"		96"	96"	96"
Textured Steel 20GU	96"	96"	96"	84"	96"	84"		96"	96"	96"
Fiberglass										
Regency & Aspen Oak	84"	84"	84"	80"	84"	84"		84"	84"	84"
Regency & Aspen Cherry	84"	84"	84"		84"	84"	84"	84"	96"	84"
Regency & Aspen Mahogany		84"	84"		84"			84"	84"	84"
Regency & Aspen Fir									84"	
Regency & Aspen Smooth	84"	80"	84"		80"	84"		80"	84"	84"



HME 274-LIN Door and HS 242-LIN Sidelites ▲



HM 212-LIN



HME 224-LIN



HM 242-LIN



HME 254-LIN



HME 268-LIN



HME 274-LIN



HME 279-LIN

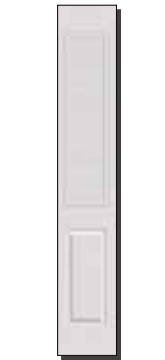

HSE 224-LIN



HS 242-LIN



HSE 268-LIN

MODA Trim



- Optional
- Made of extruded aluminum
- No Screw Plugs
- Ideal for dark doors behind storm doors

STD Trim



- Standard Trim with Factory Installed Screw Plugs (inside of the house)

Privacy Level

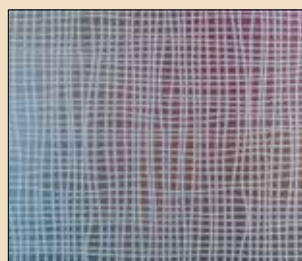
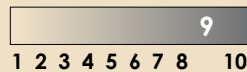

Linen Glass Door Styles

	212	224	242	254	268	274	279	224	242	268
Price Book Page	28	44	31	52	56	58	62	76	72	78

Steel

Smooth Steel 20GU	96"	96"	96"	84"	96"	84"		96"	96"	96"
Textured Steel 20GU	96"	96"	96"	84"	96"	84"		96"	96"	96"

Fiberglass

Regency & Aspen Oak	84"	84"	84"	80"	84"	84"		84"	84"	84"
Regency & Aspen Cherry	84"	84"	84"		84"	84"	84"	84"	96"	84"
Regency & Aspen Mahogany		84"	84"		84"			84"	84"	84"
Regency & Aspen Fir									84"	
Regency & Aspen Smooth	84"	80"	84"		80"	84"		80"	84"	84"

LAFAYETTE LASERCUT



Custom Glass Sizes Available Door / Sidelite / Transom

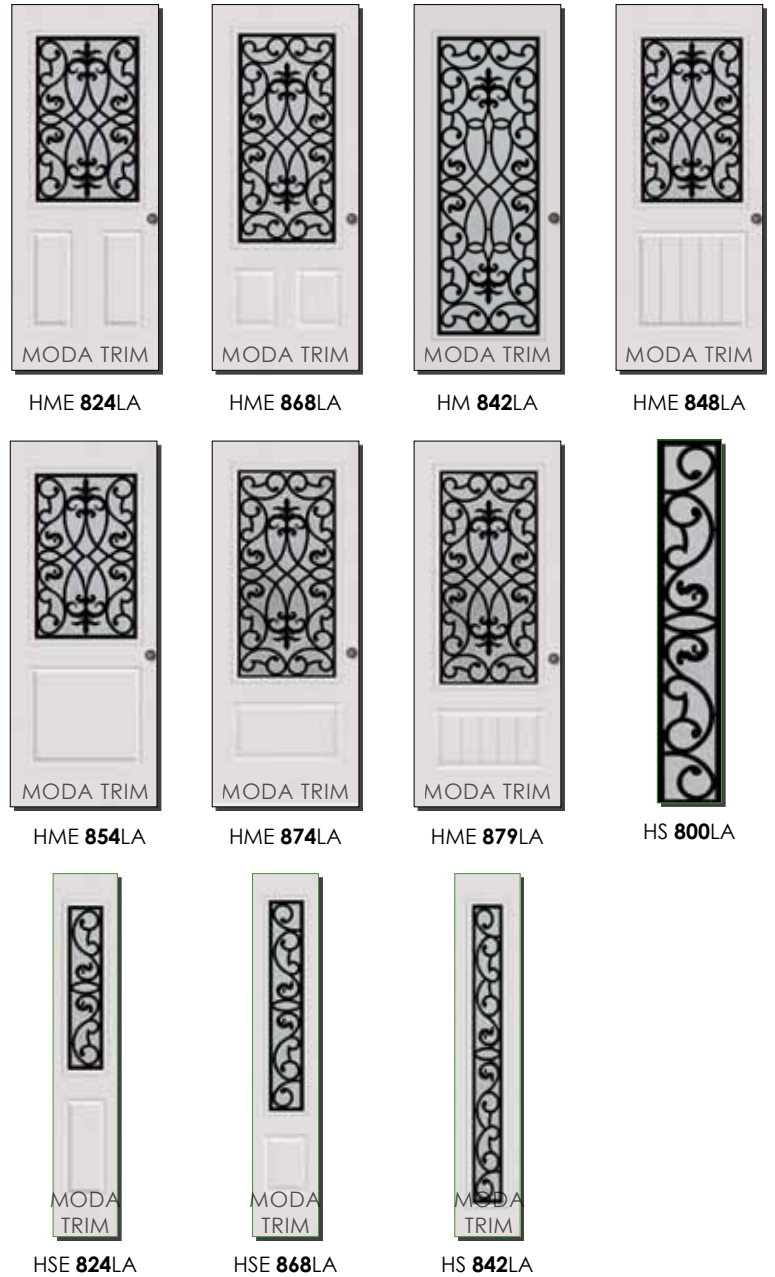

HME 874LA Door, HSE 868LA Sidelites and HT 800LA Transom ▲

Internal grids are painted black



HT 800LA pg. 89

MODA Trim



- Made of extruded aluminum
- No Screw Plugs
- Ideal for dark doors behind storm doors

Privacy Level

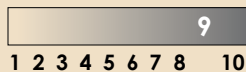

Micro-Granite - MG (Old Pebbled)

Lafayette Glass Door Styles

	824	842	848	854	868	874	879	800	824	842	868
--	-----	-----	-----	-----	-----	-----	-----	-----	-----	-----	-----

Price Book Page	44	32	51	53	57	59	63	71	76	73	78
-----------------	----	----	----	----	----	----	----	----	----	----	----

Steel

Smooth Steel 20GU	96"	96"	84"	84"	96"	84"		96"	96"	96"	84"
Textured Steel 20GU	96"	96"	84"	84"	96"	84"		96"	96"	96"	84"

Fiberglass

Regency & Aspen Oak	84"	84"	80"	80"	84"	84"			84"	84"	84"
Regency & Aspen Cherry	84"	84"			84"	84"	84"		84"	96"	84"
Regency & Aspen Mahogany	84"	84"			84"				84"	84"	84"
Regency & Aspen Smooth	80"	84"			80"	84"			80"	84"	84"

VALENCIA LASERCUT

Custom Glass Sizes Available Door / Sidelite / Transom



HM 842VA Door, HS 842VA Sidelites and HT 800VA Transom ▲

Internal grids are painted black



HT 800VA pg. 90



HME 824VA



HME 868VA

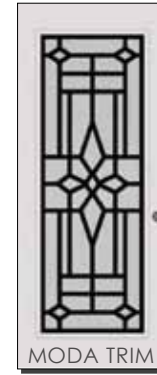

HM 842VA



HME 848VA



HME 854VA



HME 874VA



HME 879VA



HS 800VA



HSE 824VA



HSE 868VA



HS 842VA

MODA Trim



- Made of extruded aluminum
- No Screw Plugs
- Ideal for dark doors behind storm doors

Privacy Level

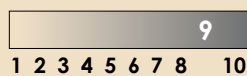

Micro-Granite - MG
(Old Pebbled)

Valencia Glass Door Styles

Price Book Page	44	32	51	53	57	59	63	71	76	73	78
Steel											
Smooth Steel 20GU	96"	96"	84"	84"	84"	84"		96"	96"	96"	96"
Textured Steel 20GU	96"	96"	84"	84"	84"	84"		96"	96"	96"	96"
Fiberglass											
Regency & Aspen Oak	84"	84"	80"	80"	84"	84"			84"	84"	84"
Regency & Aspen Cherry	84"	84"			84"	84"	84"		84"	96"	84"
Regency & Aspen Mahogany	84"	84"			84"				84"	84"	84"
Regency & Aspen Smooth	80"	84"			80"	84"			80"	84"	84"

ROME LASERCUT

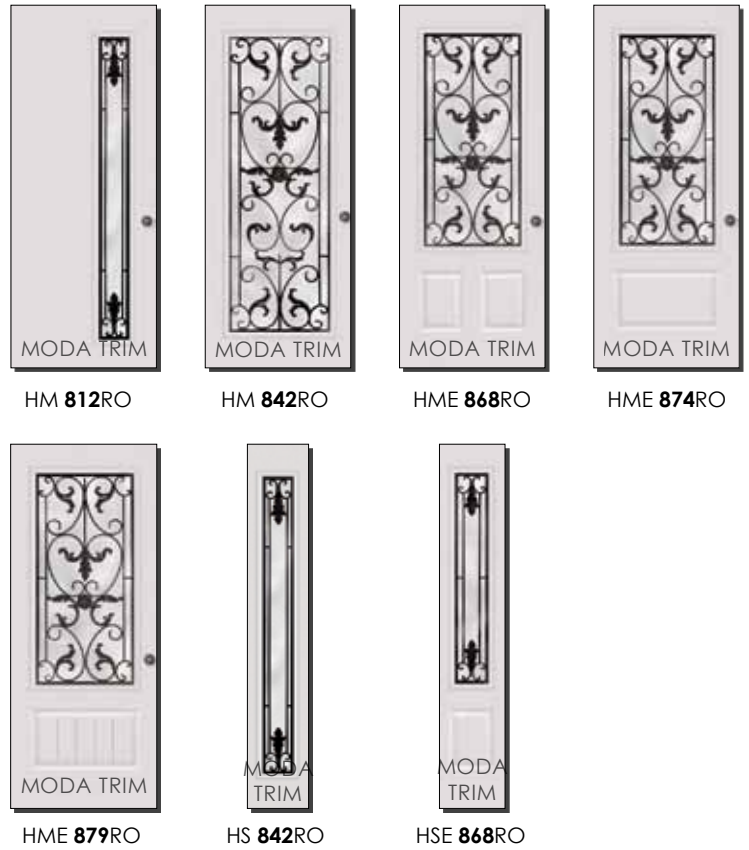

HM 842RO Door and HS 842RO Sidelites ▲

Internal grids are painted black

MODA Trim



- Made of extruded aluminum
- No Screw Plugs
- Ideal for dark doors behind storm doors

Privacy Level

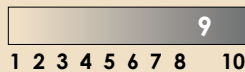

Micro-Granite - MG
(Old Pebbled)

Rome Glass Door Styles	812	842	868	874	879	842	868
Price Book Page	28	32	57	59	63	73	78
Steel							
Smooth Steel 20GU	96"	96"	96"			96"	96"
Textured Steel 20GU	96"	96"	84"			96"	84"
Fiberglass							
Regency & Aspen Mahogany		84"	84"			84"	84"
Regency & Aspen Cherry	96"	96"	84"	84"	84"	96"	84"
Regency & Aspen Mahogany							
Regency & Aspen Smooth	84"	84"	80"	84"		84"	84"

FLORENCE LASERCUT

Custom Glass Sizes Available Door / Sidelite / Transom



HME 879FL Door and HSE 868FL Sidelites ▲

Internal grids are painted black



HT 800FL pg. 89

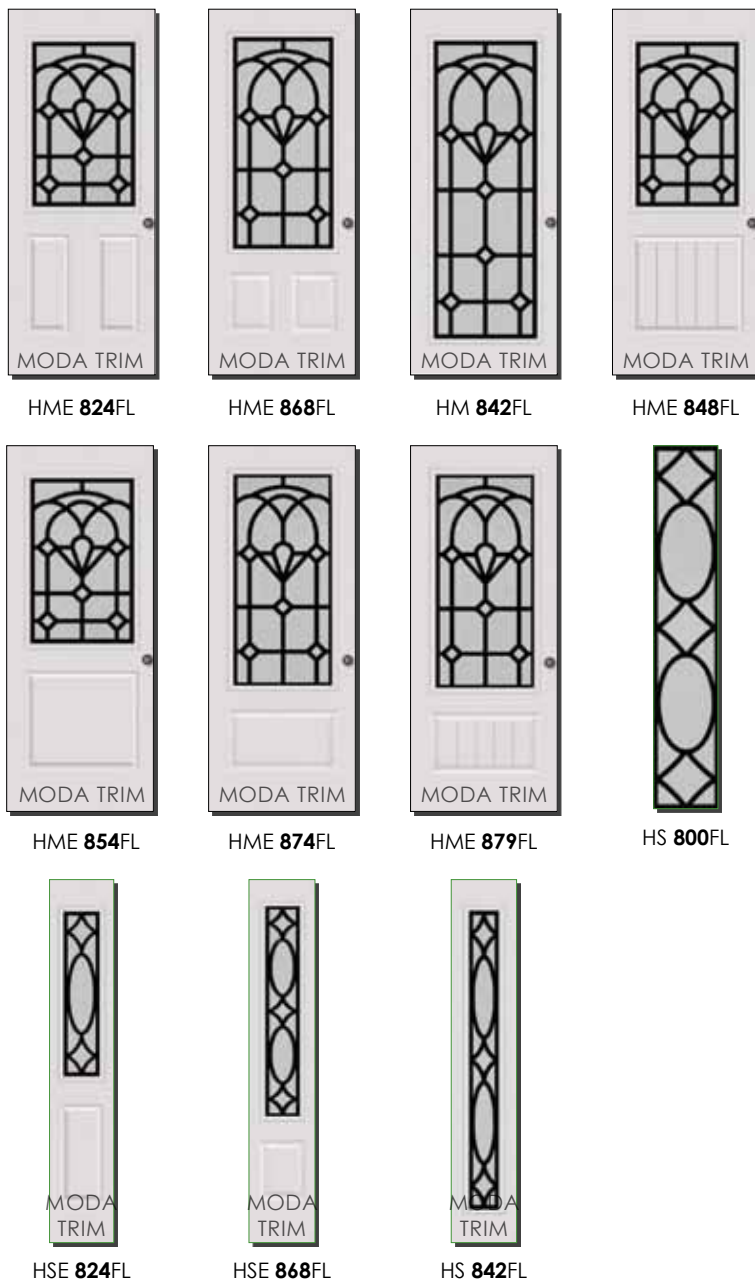

MODA Trim



- Made of extruded aluminum
- No Screw Plugs
- Ideal for dark doors behind storm doors

Privacy Level

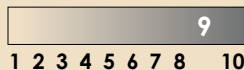

Micro-Granite - MG
(Old Pebbled)

Florence Glass Door Styles												
	824	842	848	854	868	874	879	898	800	824	842	868
Price Book Page	44	32	51	53	57	59	63	65	71	76	73	78
Steel												
Smooth Steel 20GU	96"	96"	84"	84"	84"	84"				96"	96"	84"
Textured Steel 20GU	96"	96"	84"	84"	84"	84"				96"	96"	84"
Fiberglass												
Regency & Aspen Oak	84"	84"	80"	80"	84"	84"				84"	84"	84"
Regency & Aspen Cherry	84"	84"			84"	84"	84"	84"		84"	96"	84"
Regency & Aspen Mahogany	84"	84"			84"					84"	84"	84"
Regency & Aspen Smooth	80"	84"			80"	84"				80"	84"	84"

COURTYARD

by ODL



HME 274-CTD ▲



HME 224-CTD

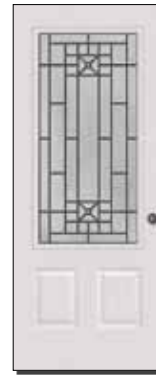

HME 268-CTD

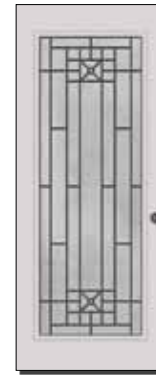

HM 242-CTD



HME 248-CTD



HME 249-CTD



HME 254-CTD

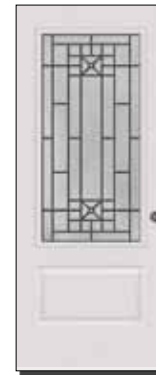

HME 274-CTD

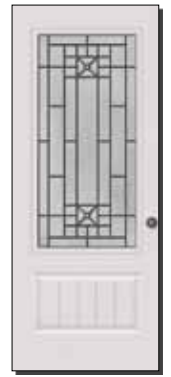

HME 279-CTD



HME 286-CTD



HME 287-CTD



HSE 224-CTD



HSE 268-CTD



HS 242-CTD

Caming Available



Privacy Level

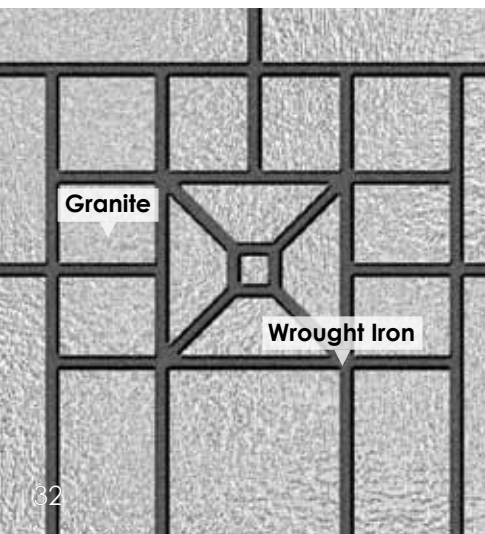

Courtyard Glass Door Styles

Price Book Page

Steel

Smooth Steel 20GU

Textured Steel 20GU

Fiberglass

Regency & Aspen Oak

Regency & Aspen Cherry

Regency & Aspen Mahogany

Regency & Aspen Smooth

	224	242	248	249	254	268	274	279	286	287	224	242	268
--	-----	-----	-----	-----	-----	-----	-----	-----	-----	-----	-----	-----	-----

Price Book Page	44	32	51	68	53	57	59	63	66	69	76	73	78
-----------------	----	----	----	----	----	----	----	----	----	----	----	----	----

Smooth Steel 20GU	96"	96"	84"	84"	84"	96"	84"		84"	84"	96"	96"	84"
Textured Steel 20GU	96"	96"	84"	84"	84"	96"	84"		84"	84"	96"	96"	84"

Regency & Aspen Oak	84"	84"	80"		80"	84"	84"				84"	84"	84"
Regency & Aspen Cherry	84"	84"				84"	84"	84"			84"	96"	84"
Regency & Aspen Mahogany	84"	84"				84"					84"	84"	84"
Regency & Aspen Smooth	80"	84"				80"	84"				80"	84"	84"

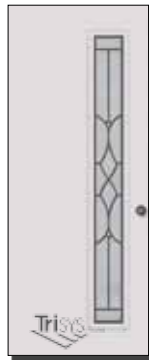
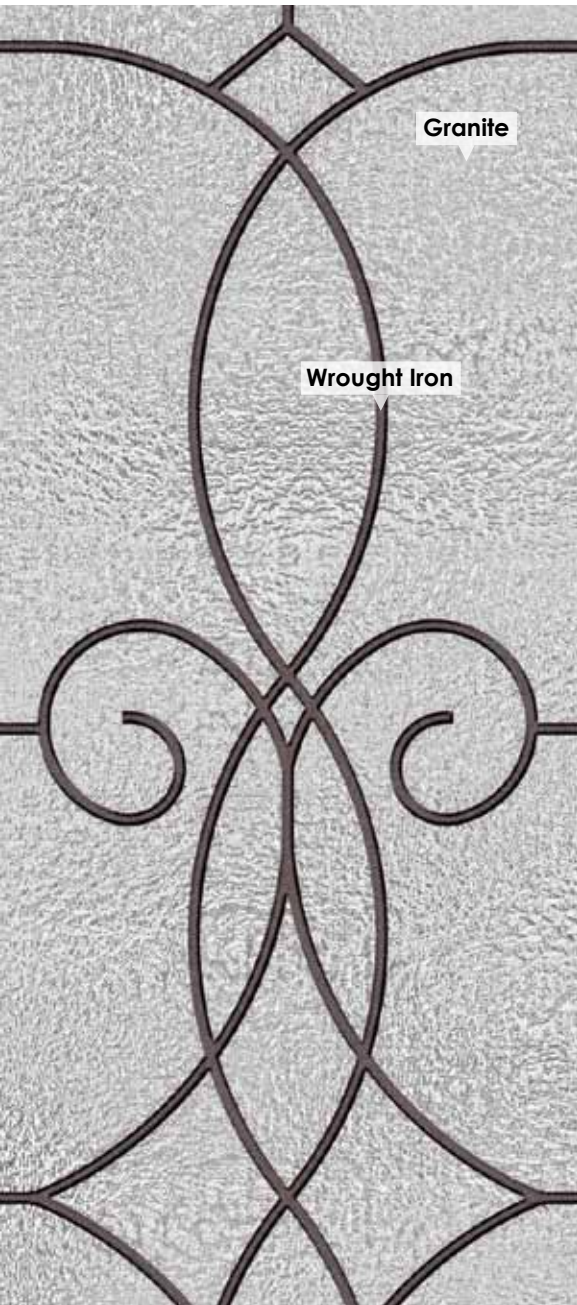

● HM 212ASH

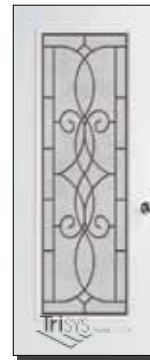

● HM 242ASH



● HME 268ASH



● HME 274ASH



● HME 279ASH

● HM 242ASH Door, ● HS 242ASH Sidelites and ● HT 230ASH Transom ▼



● HS 242ASH



● HSE 268ASH



Caming Available

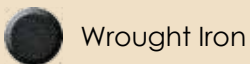

STD Trim



- Standard Trim with Factory Installed Screw Plugs (inside of the house)

Privacy Level

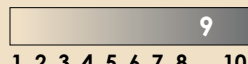

MODA Trim



- Optional
- Made of extruded aluminum
- No Screw Plugs
- Ideal for dark doors behind storm doors

Ashbury Glass Door Styles	212	242	268	274	279	242	268
Price Book Page	28	31	56	58	62	72	78
Steel							
Smooth Steel 20GU	96"	96"	96"	84"		96"	96"
Textured Steel 20GU	96"	96"	84"	84"		96"	84"
Fiberglass							
Regency & Aspen Oak	84"	84"	84"	84"		84"	84"
Regency & Aspen Cherry	84"	84"	84"	84"	84"	84"	84"
Regency & Aspen Mahogany		84"	84"			84"	84"
Regency & Aspen Smooth	84"	84"	80"	84"		84"	84"

HEIRLOOM

by ODL

● HME 268N Door and ● HSE 268N Sidelites ▼

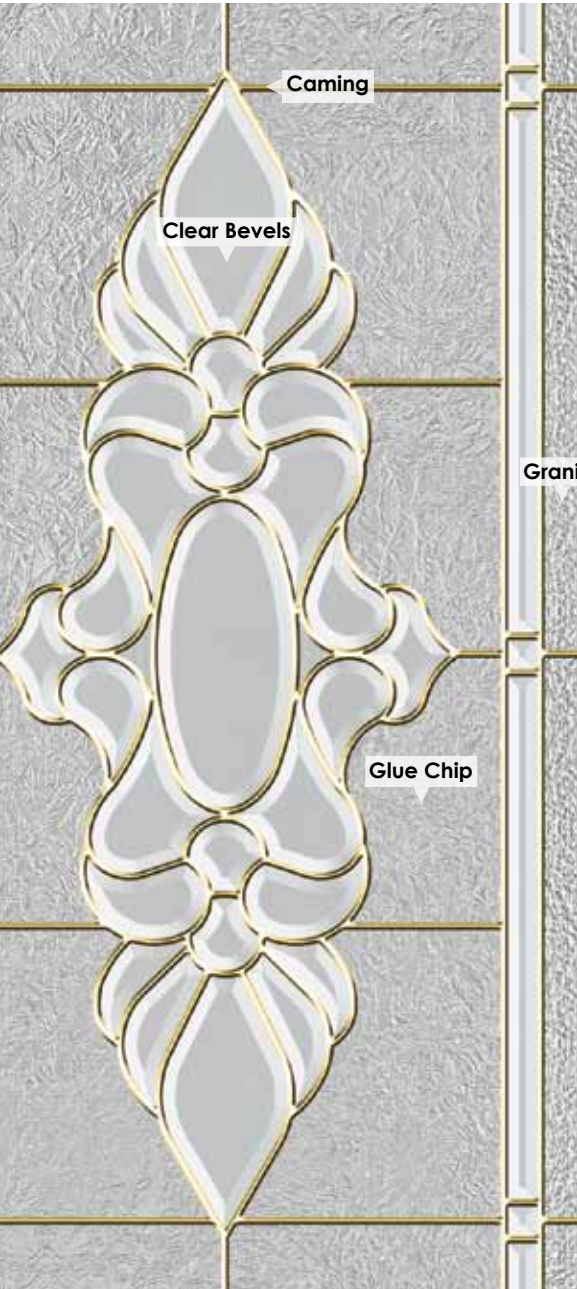

Caming Available

● Polish Brass

● Satin Nickel

Privacy Level



STD Trim



- Standard Trim with Factory Installed Screw Plugs (inside of the house)

MODA Trim



- Optional
- Made of extruded aluminum
- No Screw Plugs
- Ideal for dark doors behind storm doors



- HM 210N
- HM 210NS
- HM 212N
- HM 212NS
- HM 216N
- HM 216NS
- HME 218N
- HME 218NS
- HME 224N
- HME 224NS
- HME 230N
- HME 230NS
- HME 238N
- HME 238NS
- HM 242N
- HM 242NS
- HME 248N
- HME 248NS
- HME 254N
- HME 254NS



- HME 263N
- HME 263NS
- HME 266N
- HME 266NS
- HME 268N
- HME 268NS
- HME 272N
- HME 272NS
- HME 274N
- HME 274NS
- HME 279N
- HME 279NS
- HME 284N
- HME 284NS

FRENCH SIDELITES

See Page 67 For Details



- HSE 224N
- HSE 224NS
- HS 242N
- HS 242NS
- HSE 268N
- HSE 268NS
- HT 200N
- HT 200NS
- HT 230N
- HT 230NS

pg. 91

pg. 93

HM 242N Door and HS 242N Sidelite



Available in Severe Weather Glass

Heirloom Glass Door Styles	210	212	216	218	224	230	238	242	248	254	263	266	268	272	274	279	284	224	242	268
Price Book Page	27	28	46	42	44	48	30	31	50	52	54	55	56	49	58	62	30	76	72	78
Steel																				
Smooth Steel 20GU	96"	96"	96"	96"	96"	96"	84"	96"	84"	84"	84"	84"	96"	84"	84"		84"	96"	96"	96"
Textured Steel 20GU	96"	96"	96"	96"	96"	96"	84"	96"	84"	84"	84"	84"	84"	84"	84"		84"	96"	96"	96"
Fiberglass																				
Regency & Aspen Oak	84"	84"	84"	80"	84"		80"	84"	80"	80"	84"	84"	84"		84"		84"	84"	84"	84"
Regency & Aspen Cherry	84"	84"	84"		84"			84"			84"	84"	84"		84"	84"	84"	84"	96"	84"
Regency & Aspen Mahogany					84"			84"			84"	84"	84"					84"	84"	84"
Regency & Aspen Smooth	84"	84"	84"	80"	80"	80"		84"					80"	80"	84"			80"	84"	84"

NOUVEAU

by ODL

● HM 242AP Door, ● HS 242AP Sidelites and ● HT 200AP Transom ▼

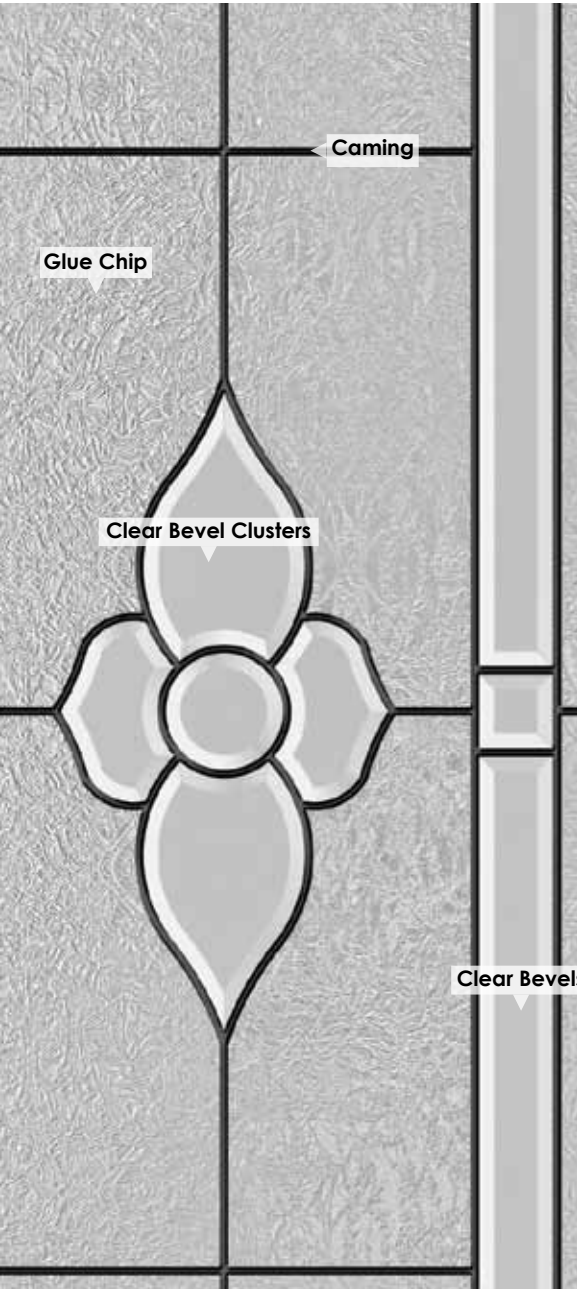

Caming Available



Satin Nickel



Patina (black)

Privacy Level

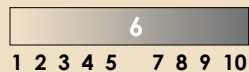

STD Trim

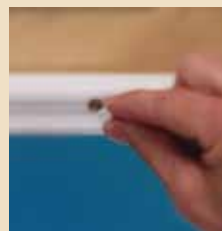

- Standard Trim with Factory Installed Screw Plugs (inside of the house)

MODA Trim



- Optional
- Made of extruded aluminum
- No Screw Plugs
- Ideal for dark doors behind storm doors



- HM 210AS ● HM 212AS ● HM 216AS ● HME 218AS ● HME 223AS ● HME 224AS ● HME 226AS ● HME 230AS ● HME 238AS
- HM 210AP ● HM 212AP ● HM 216AP ● HME 218AP ● HME 223AP ● HME 224AP ● HME 226AP ● HME 230AP ● HME 238AP



- HM 242AS ● HME 248AS ● HME 254AS ● HME 263AS ● HME 266AS ● HME 268AS ● HME 272AS ● HME 274AS ● HME 279AS
- HM 242AP ● HME 248AP ● HME 254AP ● HME 263AP ● HME 266AP ● HME 268AP ● HME 272AP ● HME 274AP ● HME 279AP



- HSE 224AS ● HS 242AS ● HSE 268AS
- HSE 224AP ● HS 242AP ● HSE 268AP



- HT 230AS pg. 94
- HT 230AP



- HT 200AS pg. 91
- HT 200AP

Nouveau Glass Door Styles

	210	212	216	218	223	224	226	230	238	242	248	254	263	266	268	272	274	279	224	242	268
Price Book Page	27	28	46	42	43	44	47	48	30	31	50	52	54	55	56	49	58	62	76	72	78

Steel

Smooth Steel 20GU	96"	96"	96"	96"	96"	96"	96"	84"	84"	96"	84"	84"	84"	84"	96"	84"	84"		96"	96"	96"
Textured Steel 20GU	96"	96"	96"	96"	96"	96"	96"	84"	84"	96"	84"	84"	84"	84"	84"	84"	84"		96"	96"	84"

Fiberglass

Regency & Aspen Oak	84"	84"	84"	80"	84"	84"	80"	80"	80"	84"	80"	80"	84"	84"	84"		84"		84"	84"	84"
Regency & Aspen Cherry	84"	84"	84"		84"	84"				84"			84"	84"	84"		84"	84"	84"	96"	84"
Regency & Aspen Mahogany					84"	84"				84"			84"	84"	84"				84"	84"	84"
Regency & Aspen Smooth	84"	84"	84"	80"	80"	80"				84"					80"	80"	84"		80"	84"	84"

LIBERTY / INDEPENDENCE

by RSL



HME 268LB Door ▲

Caming Available

-  Satin Nickel
-  Patina (black)

Privacy Level



- HM 212LBS
- HM 212LBP
- HME 224LBS
- HME 224LBP
- HM 242LBS
- HM 242LBP
- HME 254LBS
- HME 254LBP
- HME 268LBS
- HME 268LBP
- HME 274LBS
- HME 274LBP
- HME 279LBS
- HME 279LBP
- HSE 224LBS
- HSE 224LBP
- HS 242LBS
- HS 242LBP
- HSE 268LBS
- HSE 268LBP

MODA Trim



- Optional
- Made of extruded aluminum
- No Screw Plugs
- Ideal for dark doors behind storm doors

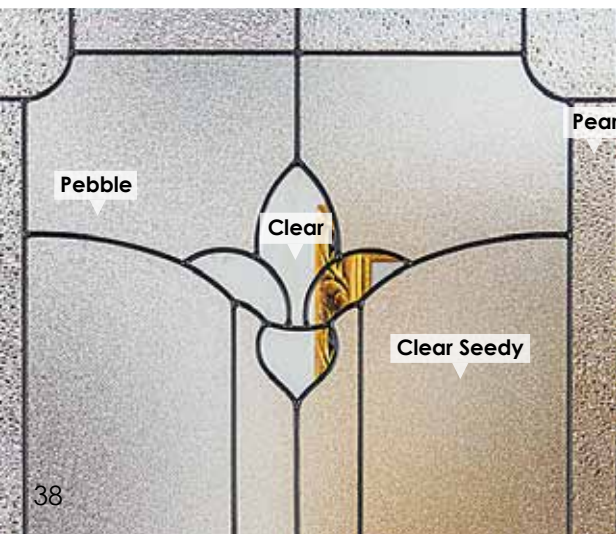

Liberty/Independence Glass Door Styles

	212	224	242	254	268	274	279	224	242	268
Price Book Page	28	44	31	52	56	58	62	76	72	78
Steel										
Smooth Steel 20GU	96"	96"	96"	84"	96"	84"		96"	96"	96"
Textured Steel 20GU	96"	96"	96"	84"	96"	84"		96"	96"	96"
Fiberglass										
Regency & Aspen Oak	84"	84"	84"	80"	84"	84"		84"	84"	84"
Regency & Aspen Cherry	84"	84"	84"		84"	84"	84"	84"	96"	84"
Regency & Aspen Mahogany		84"	84"		84"			84"	84"	84"
Regency & Aspen Fir									84"	
Regency & Aspen Smooth	84"	80"	84"		80"	84"		80"	84"	84"



HME 224KP Door and HS 242KP Sidelites ▲

Caming Available

Privacy Level

● Patina (black)

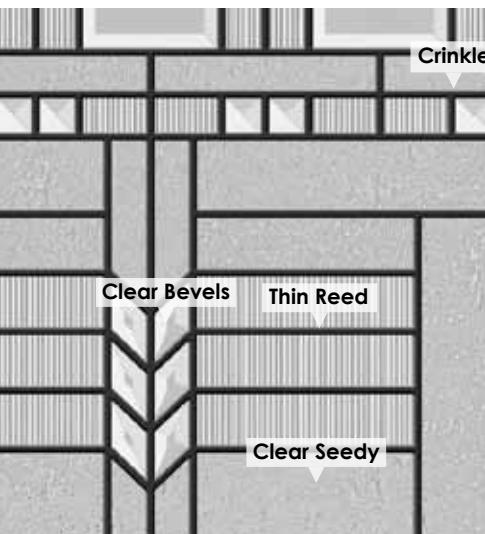
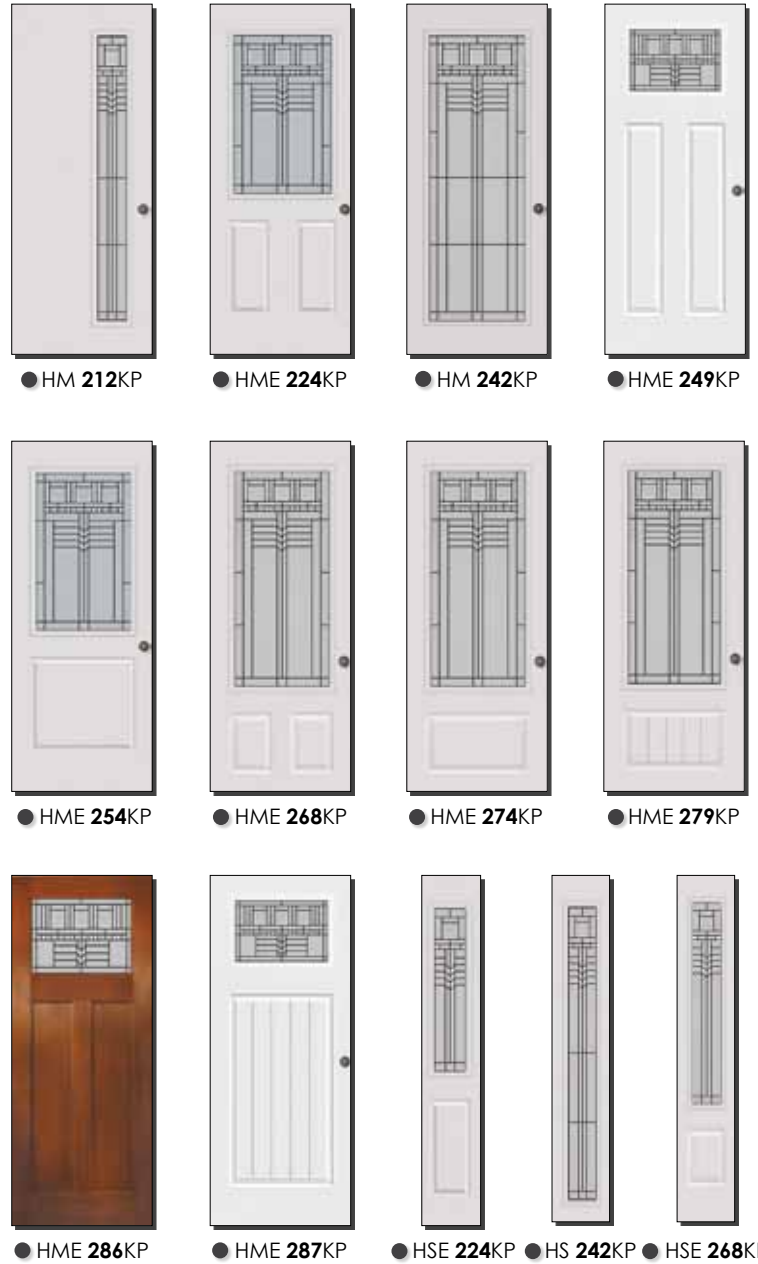
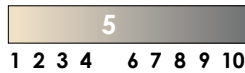

Oak Park Glass Door Styles	212	224	242	249	254	268	274	279	286	287	224	242	268
Price Book Page	28	44	31	68	52	56	58	62	66	69	76	72	78
Steel													
Smooth Steel 20GU	96"	96"	96"	84"	84"	96"	84"			84"	96"	96"	96"
Textured Steel 20GU	96"	96"	96"	84"	84"	96"	84"			84"	96"	96"	96"
Fiberglass													
Regency & Aspen Oak	84"	84"	84"		80"	84"	84"				84"	84"	84"
Regency & Aspen Cherry	84"	84"	84"			84"	84"	84"			84"	96"	84"
Regency & Aspen Mahogany		84"	84"			84"					84"	84"	84"
Regency & Aspen Fir									84"			84"	
Regency & Aspen Smooth	84"	80"	84"			80"	84"		84"		80"	84"	84"

SYLVAN PARK

by Western Reflections

● HM 242PRK Door, ● HS 242PRK Sidelites and ● HT 200PRK Transom ▼

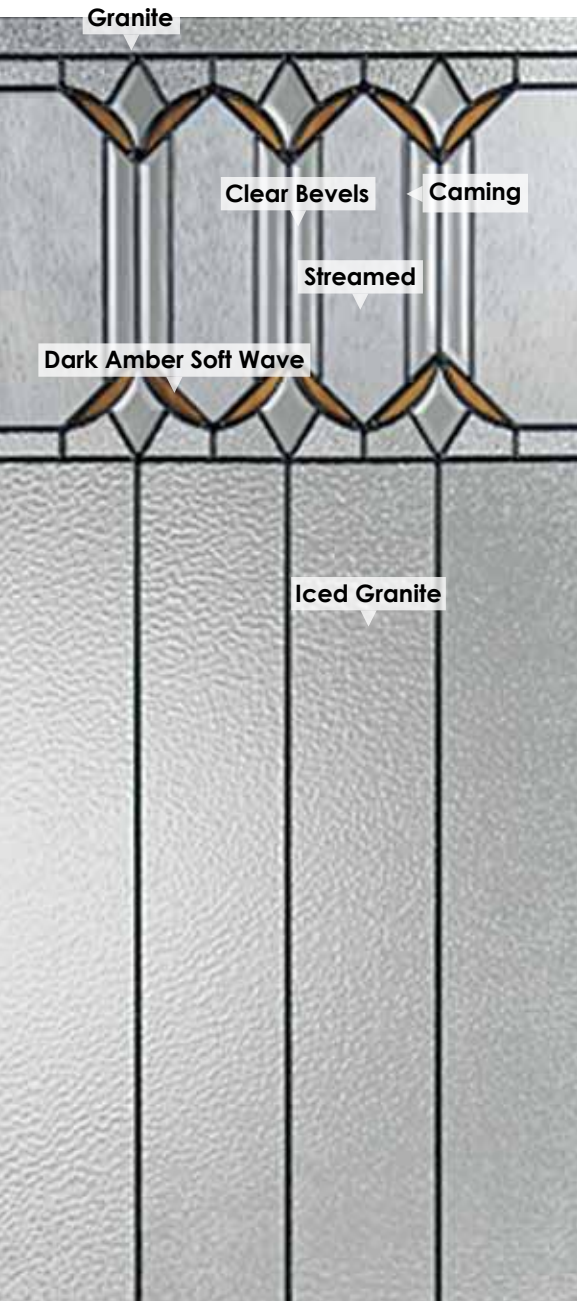

Caming Available

● Patina (black)

Privacy Level

1 2 3 4 5 6 7 8 9 10

STD Trim



- Standard Trim with Factory Installed Screw Plugs (inside of the house)

MODA Trim



- Optional
- Made of extruded aluminum
- No Screw Plugs
- Ideal for dark doors behind storm doors



Sylvan Park Glass Door Styles

	210	212	223	227	230	242	249	263	268	272	274	279	285	286	287	224	242	268
Price Book Page	27	28	43	47	48	31	68	54	56	49	58	62	70	66	69	76	72	78

Steel																		
Smooth Steel 20GU	96"	96"	96"	96"	96"	96"	84"	84"	96"	96"	84"		84"		84"	96"	96"	96"
Textured Steel 20GU	96"	96"	96"	96"	96"	96"	84"	84"	84"	84"	84"		84"		84"	96"	96"	84"

Fiberglass																		
Regency & Aspen Oak	84"	84"	84"	80"		84"		84"	84"		84"		84"			84"	84"	84"
Regency & Aspen Cherry	84"	84"	84"			84"		84"	84"	84"	84"	84"				84"	96"	84"
Regency & Aspen Mahogany			84"			84"		84"	84"							84"	84"	84"
Regency & Aspen Fir													84"				84"	
Regency & Aspen Smooth	84"	84"	80"	80"	80"	84"			80"	80"	84"		84"			80"	84"	84"

RENEWED IMPRESSIONS

by ODL

HM 242RLI Door and HS 242RLI Sidelites ▼

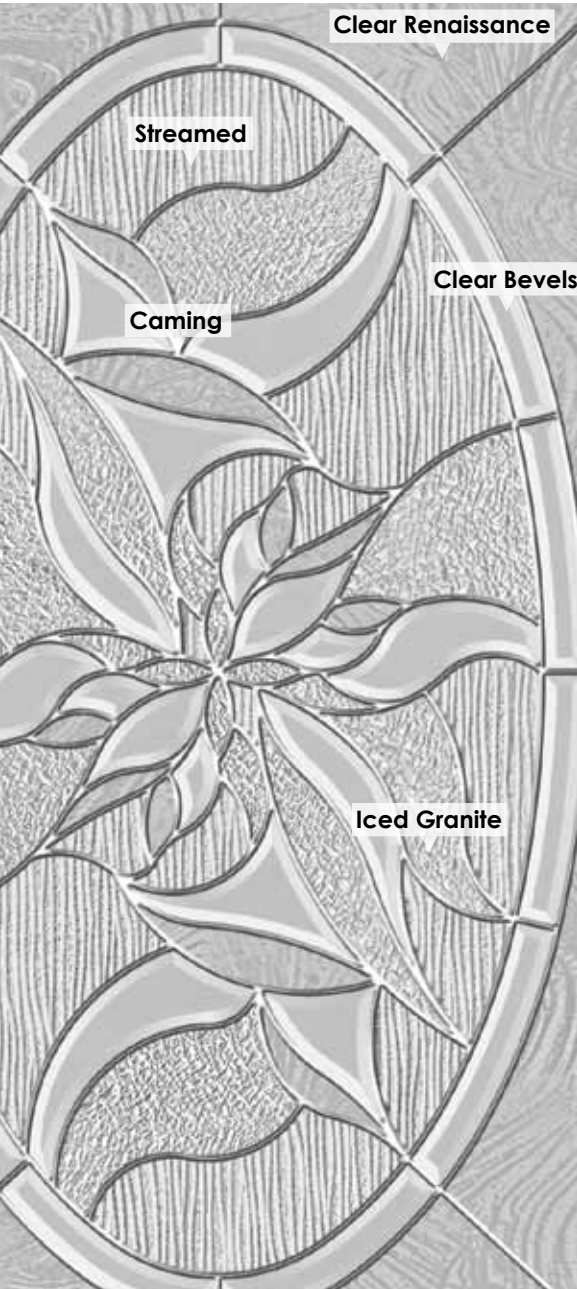

Caming Available



Privacy Level

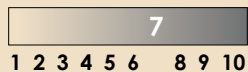

STD Trim



- Standard Trim with Factory Installed Screw Plugs (inside of the house)

MODA Trim



- Optional
- Made of extruded aluminum
- No Screw Plugs
- Ideal for dark doors behind storm doors



HM 210RLI



HM 212RLI



HM 216RLI



HME 218RLI



HME 224RLI



HME 230RLI



HM 242RLI



HME 248RLI



HME 254RLI



HME 266RLI



HSE 224RLI



HS 242RLI

FRENCH SIDELITES

See Page 67 For Details



HT 200RLI
pg. 91

HM 242N Door and HS 242N Sidelite



Available in Severe Weather Glass

Impressions Glass Door Styles	210	212	216	218	224	230	242	248	254	266	224	242
Price Book Page	27	28	46	42	44	48	31	50	52	55	76	72
Steel												
Smooth Steel 20GU	96"	96"	96"	96"	96"	84"	96"	84"	84"	84"	96"	96"
Textured Steel 20GU	96"	96"	96"	96"	96"	84"	96"	84"	84"	84"	96"	96"
Fiberglass												
Regency & Aspen Oak	84"	84"	84"	80"	84"		84"	80"	80"	84"	84"	84"
Regency & Aspen Cherry	84"	84"	84"		84"		84"			84"	96"	84"
Regency & Aspen Mahogany					84"		84"			84"	84"	84"
Regency & Aspen Smooth	84"	84"	84"	80"	80"	80"	84"				80"	84"

EMBASSY

by RSL

● HME 224Y Door and ● HS 242Y Sidelites ▼

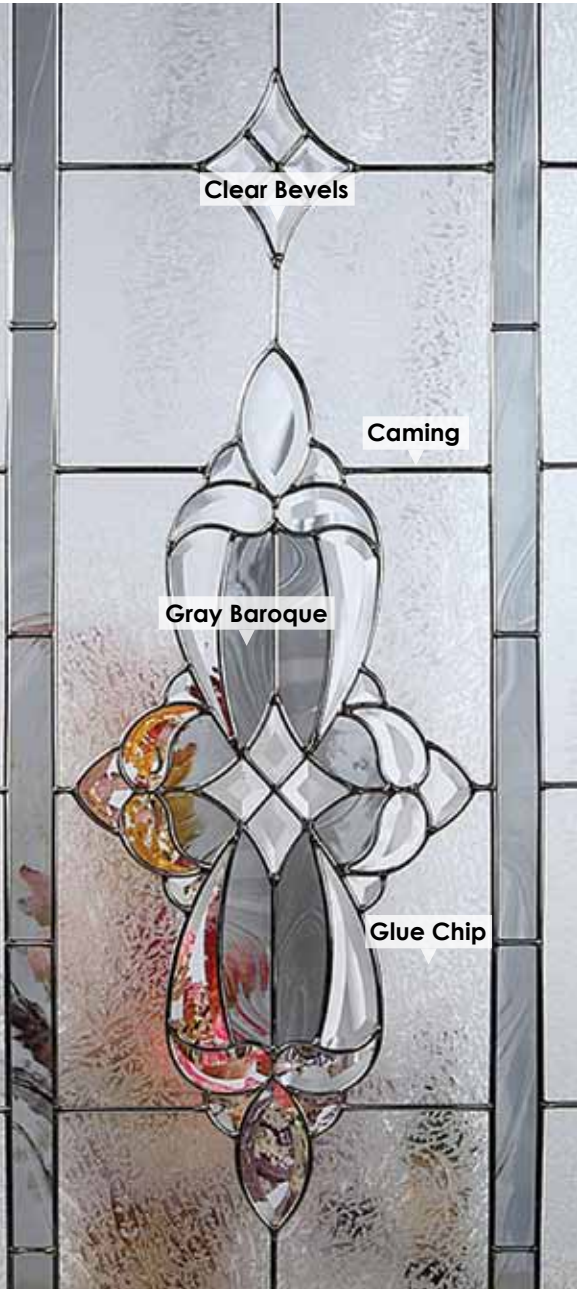

Caming Available

-  Polish Brass
-  Satin Nickel

Privacy Level

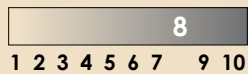

STD Trim



- Standard Trim with Factory Installed Screw Plugs (inside of the house)

MODA Trim



- Optional
- Made of extruded aluminum
- No Screw Plugs
- Ideal for dark doors behind storm doors



● HM 210Y ● HM 212Y ● HM 216Y ● HME 218Y ● HME 224Y ● HME 226Y ● HME 230Y ● HME 238Y
● HM 210YS ● HM 212YS ● HM 216YS ● HME 224YS ● HME 226YS ● HME 230YS



● HM 242Y ● HME 248Y ● HME 254Y ● HME 263Y ● HME 266Y ● HME 268Y ● HME 272Y ● HME 274Y
● HM 242YS ● HME 248YS ● HME 254YS ● HME 263YS ● HME 266YS ● HME 268YS ● HME 272YS ● HME 274YS



● HME 279Y ● HSE 224Y ● HS 242Y ● HSE 268Y
● HME 279YS ● HSE 224YS ● HS 242YS ● HSE 268YS

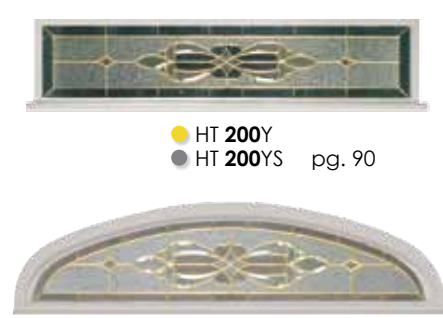

● HT 200Y ● HT 230Y
● HT 200YS ● HT 230YS pg. 90 pg. 93

Embassy Glass Door Styles	210	212	216	218	224	226	230	238	242	248	254	263	266	268	272	274	279	224	242	268
Price Book Page	27	28	46	42	44	47	48	30	31	50	52	54	55	56	49	58	62	76	72	78
Steel																				
Smooth Steel 20GU	96"	96"	96"	96"	96"	96"	84"	84"	96"	84"	84"	84"	84"	96"	84"	84"		96"	96"	96"
Textured Steel 20GU	96"	96"	96"	96"	96"	96"	84"	84"	96"	84"	84"	84"	84"	84"	84"	84"		96"	96"	84"
Fiberglass																				
Regency & Aspen Oak	84"	84"	84"	80"	84"	80"		80"	84"	80"	80"	84"	84"	84"		84"		84"	84"	84"
Regency & Aspen Cherry	84"	84"	84"		84"				84"			84"	84"	84"		84"	84"	84"	96"	84"
Regency & Aspen Mahogany					84"				84"			84"	84"	84"				84"	84"	84"
Regency & Aspen Smooth	84"	84"	84"	80"	80"	80"	80"		84"					80"	80"	84"		80"	84"	84"

● HME 238K Door ▼

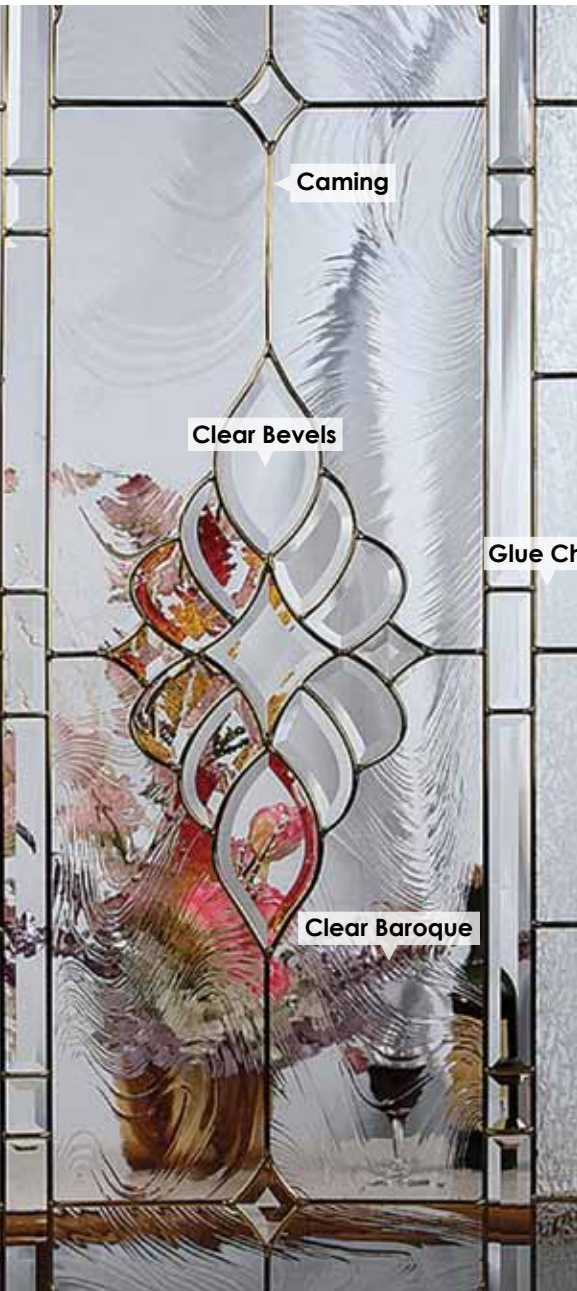

Caming Available

-  Polish Brass
-  Satin Nickel

Privacy Level



STD Trim



- Standard Trim with Factory Installed Screw Plugs (inside of the house)

MODA Trim



- Optional
- Made of extruded aluminum
- No Screw Plugs
- Ideal for dark doors behind storm doors



● HM 210K ● HM 210KS ● HM 212K ● HM 212KS ● HM 216K ● HM 216KS ● HME 218K ● HME 218KS ● HME 223K ● HME 223KS ● HME 224KS ● HME 226K ● HME 226KS ● HME 230K ● HME 230KS



● HME 238KS ● HM 242K ● HM 242KS ● HME 249KS ● HME 254K ● HME 254KS ● HME 262K ● HME 262KS ● HME 263K ● HME 263KS ● HME 266K ● HME 266KS ● HME 268K ● HME 268KS



● HME 274K ● HME 274KS ● HSE 224K ● HSE 224KS ● HS 242K ● HS 242KS ● HSE 268K ● HSE 268KS



● HT 200K ● HT 200KS pg. 90



● HT 230K ● HT 230KS pg. 93

Taj Glass Door Styles	210	212	216	218	223	224	226	230	238	242	249	254	262	263	266	268	274	224	242	268
Price Book Page	27	28	46	42	43	44	47	48	30	31	68	52	54	54	55	56	58	76	72	78

Steel																				
Smooth Steel 20GU	96"	96"	96"	96"	96"	96"	96"	84"	84"	96"	84"	84"	84"	84"	84"	96"	84"	96"	96"	96"
Textured Steel 20GU	96"	96"	96"	96"	96"	96"	96"	84"	84"	96"	84"	84"	84"	84"	84"	84"	84"	96"	96"	84"
Fiberglass																				
Regency & Aspen Oak	84"	84"	84"	80"	84"	84"	80"		80"	84"		80"	84"	84"	84"	84"	84"	84"	84"	84"
Regency & Aspen Cherry	84"	84"	84"		84"	84"				84"			84"	84"	84"	84"	84"	84"	96"	84"
Regency & Aspen Mahogany					84"	84"				84"			84"	84"	84"	84"		84"	84"	84"
Regency & Aspen Smooth	84"	84"	84"	80"	80"	80"	80"	80"		84"						80"	84"	80"	84"	84"

BLOSSOM

by RSL

● HME 266BL Door and ● HS 242BL Sidelites ▼

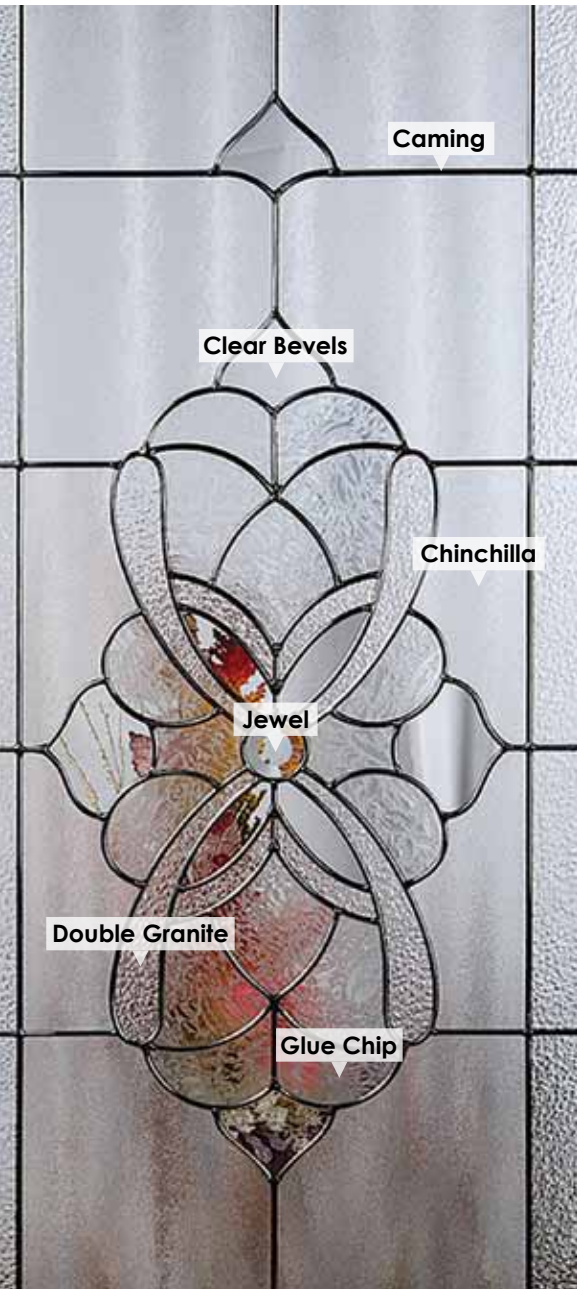

Caming Available



Privacy Level

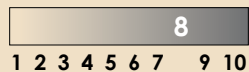

STD Trim



- Standard Trim with Factory Installed Screw Plugs (inside of the house)

MODA Trim



- Optional
- Made of extruded aluminum
- No Screw Plugs
- Ideal for dark doors behind storm doors



STD TRIM

● HM 210BL



STD TRIM

● HM 212BL



STD TRIM

● HM 216BL



STD TRIM

● HME 224BL



STD TRIM

● HME 230BL



STD TRIM

● HM 242BL



STD TRIM

● HME 248BL



STD TRIM

● HME 254BL



STD TRIM

● HME 263BL



STD TRIM

● HME 266BL



STD TRIM

● HME 268BL



STD TRIM

● HME 272BL



STD TRIM

● HME 274BL



STD TRIM

● HME 279BL



STD TRIM

● HSE 224BL



STD TRIM

● HS 242BL



STD TRIM

● HSE 268BL



● HT 200BL pg. 90



● HT 230BL pg. 93

Blossom Glass Door Styles	210	212	216	224	230	242	248	254	263	266	268	272	274	279	224	242	268
Price Book Page	27	28	46	44	48	31	50	52	54	55	56	49	58	62	76	72	78
Steel																	
Smooth Steel 20GU	96"	96"	96"	96"	96"	96"	84"	84"	84"	84"	96"	84"	84"		96"	96"	96"
Textured Steel 20GU	96"	96"	96"	96"	96"	96"	84"	84"	84"	84"	84"	84"	84"		96"	96"	84"
Fiberglass																	
Regency & Aspen Oak	84"	84"	84"	84"		84"	80"	80"	84"	84"	84"		84"		84"	84"	84"
Regency & Aspen Cherry	84"	84"	84"	84"		84"			84"	84"	84"		84"	84"	84"	96"	84"
Regency & Aspen Mahogany				84"		84"			84"	84"	84"				84"	84"	84"
Regency & Aspen Smooth	84"	84"	84"	80"	80"	84"					80"	80"	84"		80"	84"	84"

GRACE

by ODL

● HM 242GRC Door and ● HS 242GRC Sidelites ▼

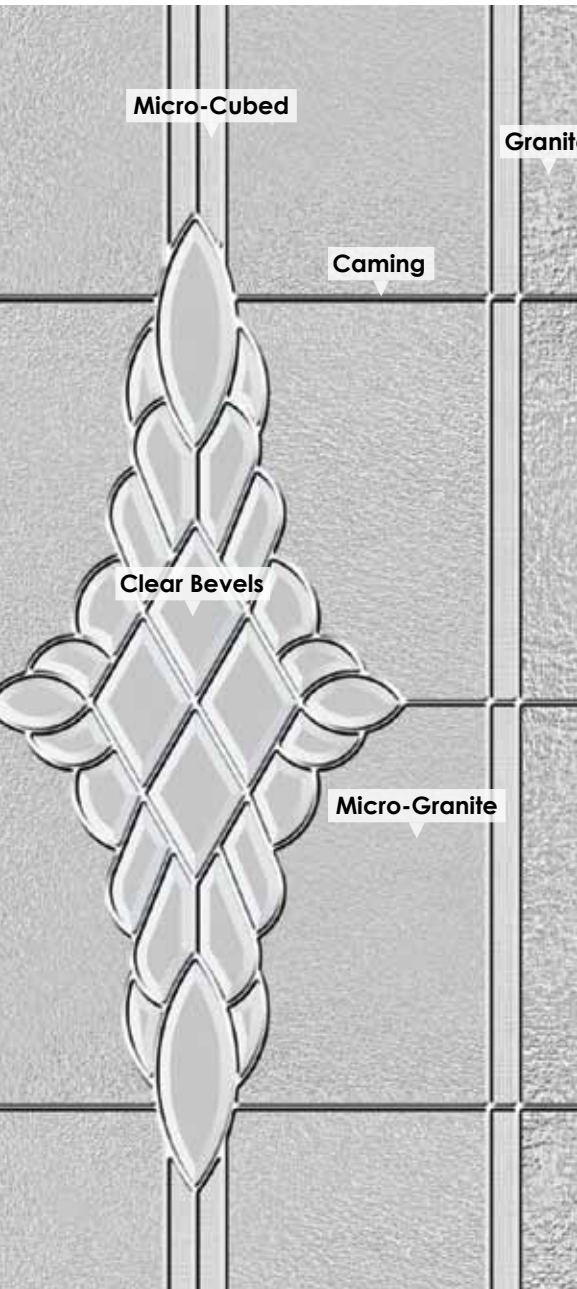

Caming Available

● Satin Nickel

● Patina (black)

Privacy Level



STD Trim



- Standard Trim with Factory Installed Screw Plugs (inside of the house)

MODA Trim



- Optional
- Made of extruded aluminum
- No Screw Plugs
- Ideal for dark doors behind storm doors



- HM 210GRC ● HM 212GRC ● HM 216GRC ● HME 218GRC ● HME 223GRC ● HME 224GRC ● HME 230GRC ● HM 242GRC
- HM 210GRP ● HM 212GRP ● HM 216GRP ● HME 218GRP ● HME 223GRP ● HME 224GRP ● HME 230GRP ● HM 242GRP



- HME 248GRC ● HME 254GRC ● HME 263GRC ● HME 266GRC ● HME 268GRC ● HME 272GRC ● HME 274GRC ● HME 279GRC
- HME 248GRP ● HME 254GRP ● HME 263GRP ● HME 266GRP ● HME 268GRP ● HME 272GRP ● HME 274GRP ● HME 279GRP



- HME 284GRC ● HSE 224GRC ● HS 242GRC ● HSE 268GRC
- HME 284GRP ● HSE 224GRP ● HS 242GRP ● HSE 268GRP

Available in Severe Weather Glass

Grace Glass Door Styles	210	212	216	218	223	224	230	242	248	254	263	266	268	272	274	279	284	224	242	268
Price Book Page	27	28	46	42	43	44	48	31	50	52	54	55	56	49	58	62	30	76	72	78
Steel																				
Smooth Steel 20GU	96"	96"	96"	96"	96"	96"	96"	96"	84"	84"	84"	84"	96"	84"	84"			96"	96"	96"
Textured Steel 20GU	96"	96"	96"	96"	96"	96"	96"	96"	84"	84"	84"	84"	84"	84"	84"			96"	96"	96"
Fiberglass																				
Regency & Aspen Oak	84"	84"	84"	80"	84"	84"		84"	80"	80"	84"	84"	84"		84"		84"	84"	84"	84"
Regency & Aspen Cherry	84"	84"	84"		84"	84"		84"			84"	84"	84"		84"	84"	84"	84"	96"	84"
Regency & Aspen Mahogany					84"	84"		84"			84"	84"	84"					84"	84"	84"
Regency & Aspen Smooth	84"	84"	84"	80"	80"	80"	80"	84"					80"	80"	84"			80"	84"	84"

LAUREL

by Western Reflections

● HM 242LRL Door and ● HS 242LRL Sidelites ▼

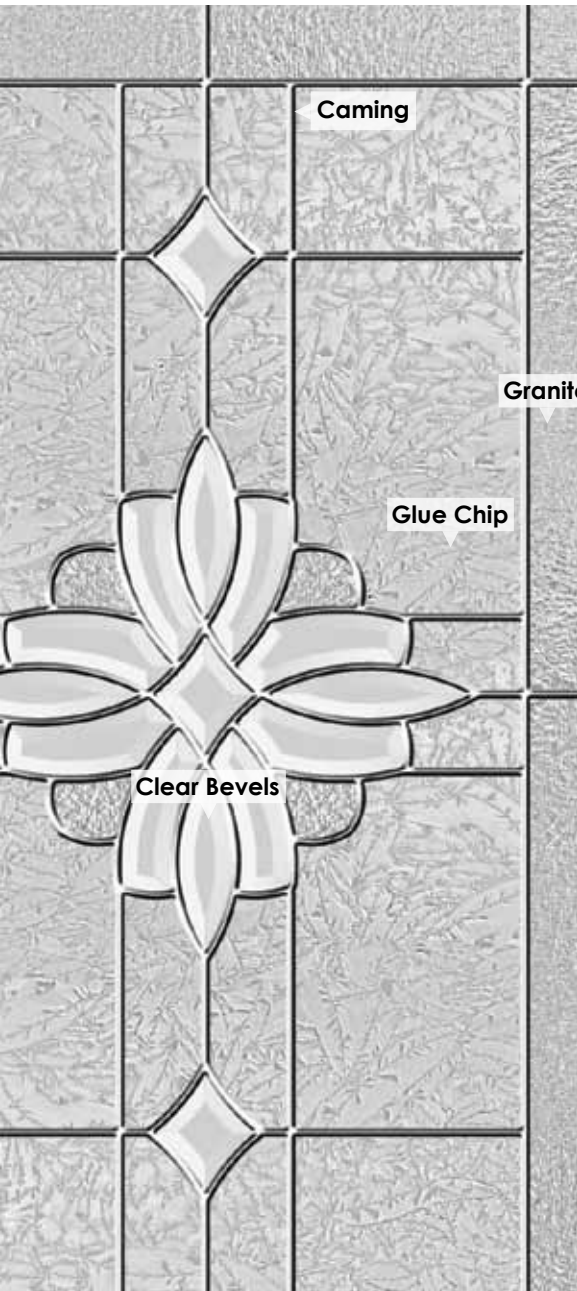

Caming Available

● Platinum

Privacy Level

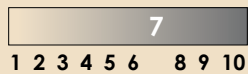

STD Trim

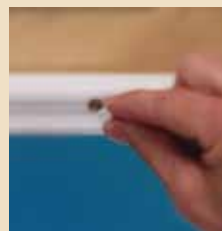

- Standard Trim with Factory Installed Screw Plugs (inside of the house)

MODA Trim



- Optional
- Made of extruded aluminum
- No Screw Plugs
- Ideal for dark doors behind storm doors

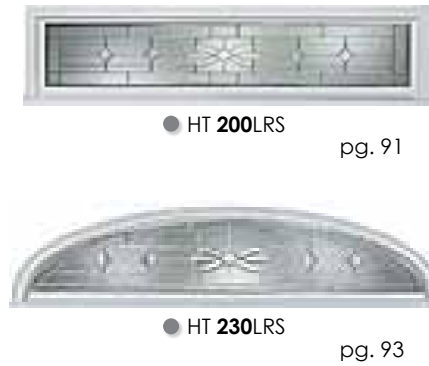

Laurel Glass Door Styles	210	212	216	218	224	227	230	242	248	249	254	263	266	285	286	287	224	242
Price Book Page	27	28	46	42	44	47	48	31	50	68	52	54	55	70	66	69	76	72
Steel																		
Smooth Steel 20GU	96"	96"	96"	96"	96"	96"	84"	96"	84"	84"	84"	84"	84"	84"		84"	96"	96"
Textured Steel 20GU	96"	96"	96"	96"	96"	96"	84"	96"	84"	84"	84"	84"	84"	84"		84"	96"	96"
Fiberglass																		
Regency & Aspen Oak	84"	84"	84"	80"	84"	80"		84"	80"		80"	84"	84"	84"			84"	84"
Regency & Aspen Cherry	84"	84"	84"		84"			84"				84"	84"	84"			84"	96"
Regency & Aspen Mahogany					84"			84"				84"	84"				84"	84"
Regency & Aspen Fir															84"			
Regency & Aspen Smooth	84"	84"	84"	80"	80"	80"	80"	84"							84"		80"	84"

FANLITE / CAMBER TOP GLASS

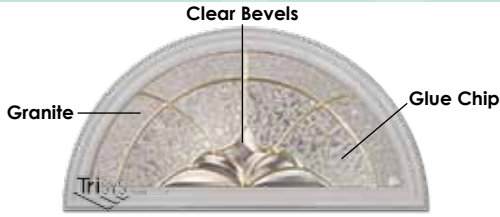

● HME 218N ● HME 218NS
Heirloom by ODL
pg. 42

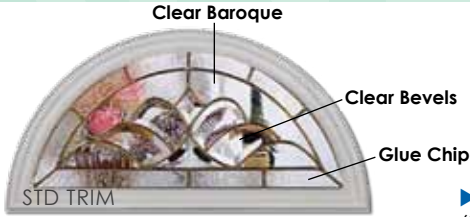

● HME 218K ● HME 218KS
Taj by RSL
pg. 42

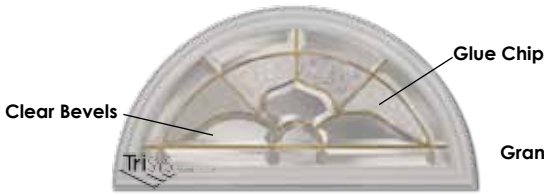

● HME 218AS ● HME 218AP
Nouveau by ODL
pg. 42

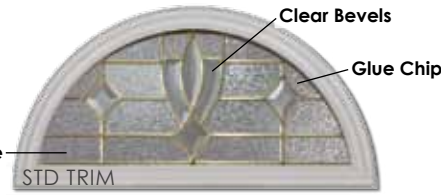

● HME 218LRS
Laurel by Western Reflections
pg. 42

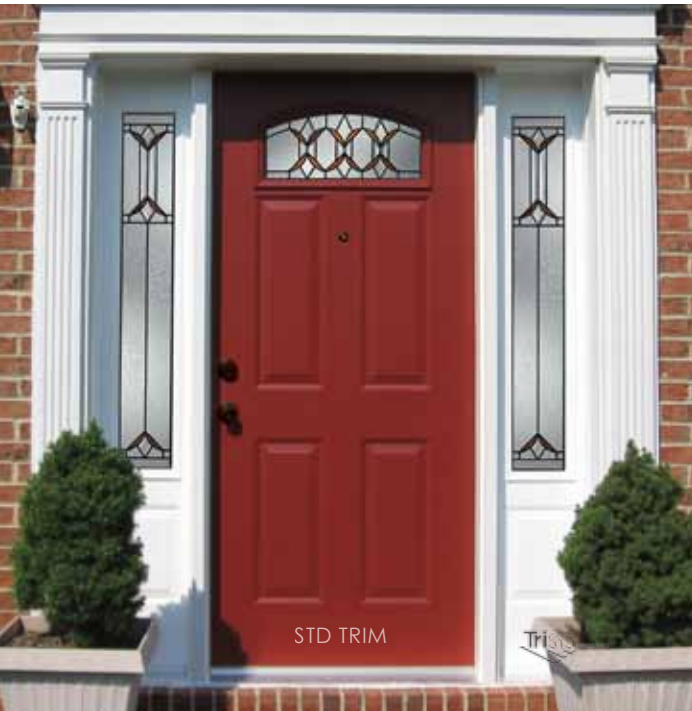

● HME 223PRK Door and ● HSE 268PRK Sidelites ▲

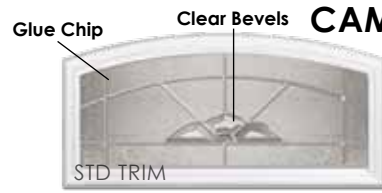

● HME 223AS ● HME 223AP
pg. 43

CAMBER TOP

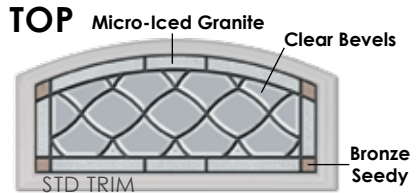

● HME 223-LON
pg. 43

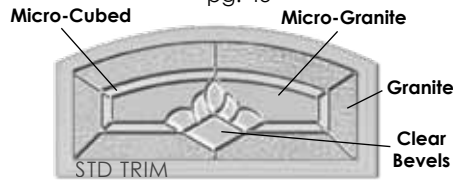

● HME 223GRC ● HME 223GRP
pg. 43

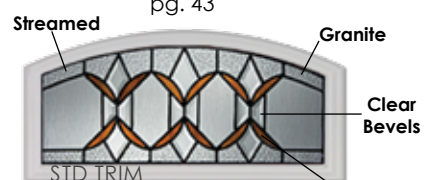

● HME 223PRK
pg. 43
Dark Amber Soft Wave

Fanlite/Camber Top
Glass Door Styles

|--|--|--|--|--|--|--|--|--|--|--|--|

Price Book Page

	42	43	68	70	69	68	68	70	70	69	69
--	----	----	----	----	----	----	----	----	----	----	----

Steel

Smooth Steel 20GU	96"	96"	84"	84"	84"	84"	84"			84"	84"
Textured Steel 20GU	96"	96"	84"	84"	84"	84"	84"			84"	84"

Fiberglass

Regency & Aspen Oak	80"	84"		84"				84"	84"		
Regency & Aspen Cherry		84"		84"				84"	84"		
Regency & Aspen Mahogany		84"									
Regency & Aspen Smooth	80"	80"									

CRAFTSMAN / ARTISAN



STD TRIM

● HME 287LRS Door ▲



Optional Dentil Shelf

HME 349-3L Door, HS 242 Sidelites and HT 200 Transom ▼



STD TRIM



STD TRIM

▲ HME 385-6L Door with optional dentil shelf and HS 242 Sidelites



STD TRIM

- HME 249 pg. 68
- HME 285 pg. 70
- HME 287 pg. 69



STD TRIM

- HME 349-6L pg. 68
- HME 385-6L pg. 70
- HME 387-6L pg. 69



STD TRIM

- HME 349-3L pg. 68
- HME 385-3L pg. 70
- HME 387-3L pg. 69

External Grid

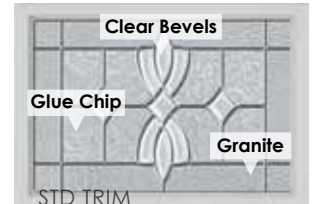

STD TRIM

- HME 249LRS pg. 68
- HME 285LRS pg. 70
- HME 287LRS pg. 69

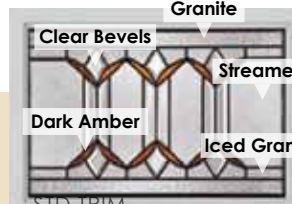

STD TRIM

- HME 249PRK pg. 68
- HME 285PRK pg. 70
- HME 287PRK pg. 69



STD TRIM

- HME 249KS pg. 68
- HME 285KS pg. 70
- HME 287KS pg. 69

Coming Available

- Polish Brass
- Satin Nickel
- Patina (black)

PHOTO GALLERY



HME 575 Door and HSE 506 Sidelites ▲



● HME 285TPZ Door with optional dentil shelf and ● HS 242TPZ Sidelites ▲

HME 253 Door and HS 842FL ▼

HM 94 Door ▼





● HME 224AS Door and ● HSE 224AS Sidelites ▲

HME 296 Door and ● HS 242PRK Sidelites ▼



HME 296 Door with optional speakeasy and 1 1/4" Clavos ▲
(See Page 16 For Details)

● HME 284NS Door and ● HSE 268NS Sidelites ▼



HM 200 SERIES - GLASS

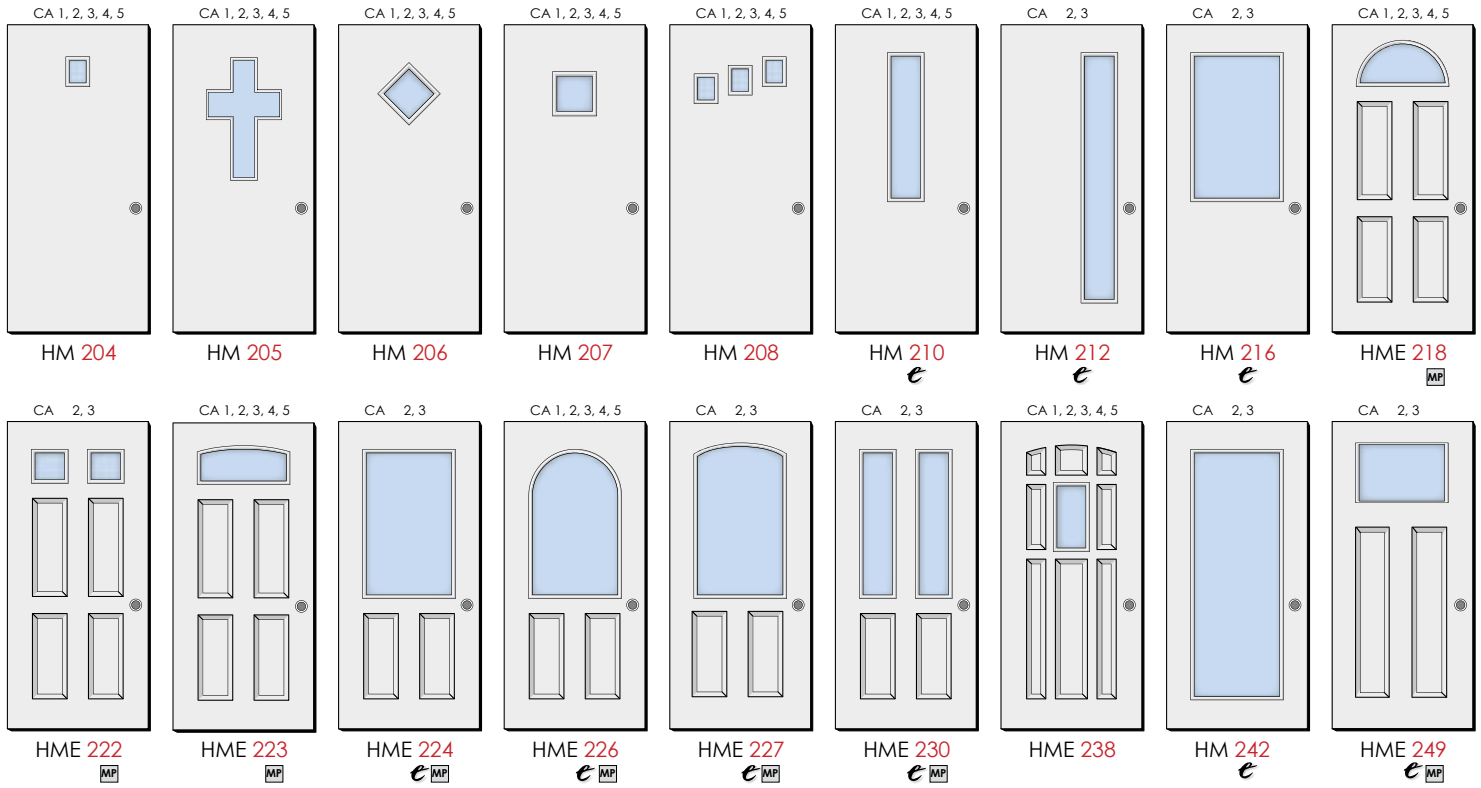

OPTIONS

Available in Low-E Glass

Available with Moda Panels

Available in Severe Weather Glass

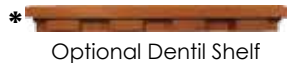

CUSTOM ARCH TOP STYLES



Micro-Granite - **MG**
(Old Pebbled)



Rain - **RN**



Streamed - **STM**

MODA Trim



- Optional
- Made of extruded aluminum
- No Screw Plugs
- Ideal for dark doors behind storm doors

HM 200 Series Door Styles	204	205	206	207	208	210	212	216	218	222	223	224	226	227	230	238	242	249
Price Book Page	26	26	26	26	26	27	28	46	42	43	43	44	47	47	48	30	31	68

	204	205	206	207	208	210	212	216	218	222	223	224	226	227	230	238	242	249		
Steel																				
Smooth Steel 20GU	96"	96"	96"	96"	96"	96"	96"	96"	96"	96"	96"	96"	96"	96"	96"	96"	84"	96"	84"	
Textured Steel 20GU	96"	96"	96"	96"	96"	96"	96"	96"	96"	96"	96"	96"	96"	96"	96"	96"	84"	84"	96"	84"
Fiberglass																				
Regency & Aspen Oak	84"	84"	84"	84"	84"	84"	84"	84"	80"	84"	84"	84"	80"	80"			80"	84"		
Regency & Aspen Cherry	84"	84"	84"	84"	84"	84"	84"	84"		84"	84"	84"						84"		
Regency & Aspen Mahogany										84"	84"	84"							84"	
Regency & Aspen Smooth	84"	84"	84"	84"	84"	84"	84"	84"	80"	80"	80"	80"	80"	80"	80"	80"			84"	
Micro-Granite - MG								•	•	•	•		•					•	•	
Rain - RN	•				•	•	•	•	•			•		•	•	•	•	•	•	
Streamed - STM						•	•	•				•			•	•	•	•	•	
Pebbled Film - PB	•	•	•	•	•					•	•									

HM 200 SERIES - GLASS

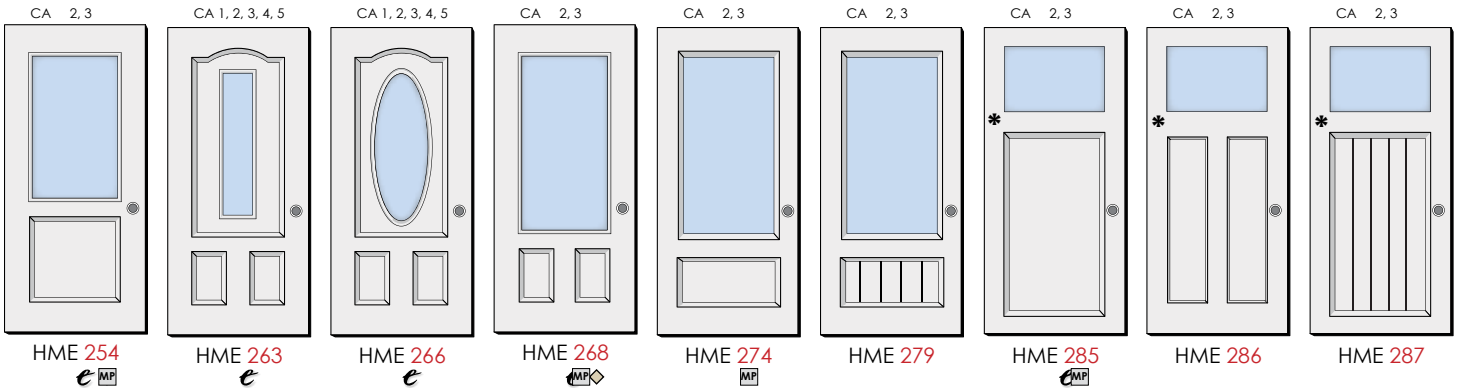

SIDELITES

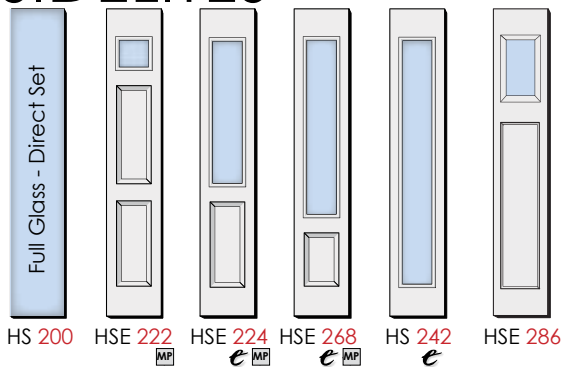

HM 242MG Door and HSE 268MG Sidelites ▲

TRANSOMS

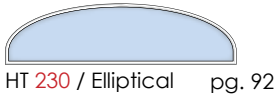
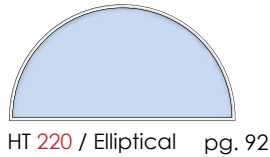

PET DOOR

We have not forgotten your best friends. A pet door can be added to doors without bottom embossed panels.



HM 200 Series Door Styles	254	263	266	268	272	274	279	284	285	286	287	200	222	224	268	242	286
Price Book Page	52	54	55	56	49	58	62	30	70	66	69	71	71	76	78	72	80
Steel																	
Smooth Steel 20GU	84"	84"	84"	96"	84"	84"			84"		84"	96"	96"	96"	96"	96"	
Textured Steel 20GU	84"	84"	84"	84"	84"	84"			84"		84"	96"	96"	96"	84"	96"	
Fiberglass																	
Regency & Aspen Oak	80"	84"	84"	84"		84"		84"	84"					84"	84"	84"	
Regency & Aspen Cherry		84"	84"	84"		84"	84"	84"	84"					84"	84"	84"	
Regency & Aspen Mahogany		84"	84"	84"										84"	84"	84"	
Regency & Aspen Fir										84"							84"
Regency & Aspen Smooth				80"	80"	84"				84"				80"	80"	84"	
Micro-Granite - MG	•	•		•	•	•	•		•	•	•			•	•	•	
Rain - RN	•	•	•	•	•	•	•		•	•	•		•	•	•	•	
Streamed - STM	•			•	•	•	•		•	•	•			•	•	•	
Pebbled Film - PB													•				

HM 200 SERIES - NO GLASS

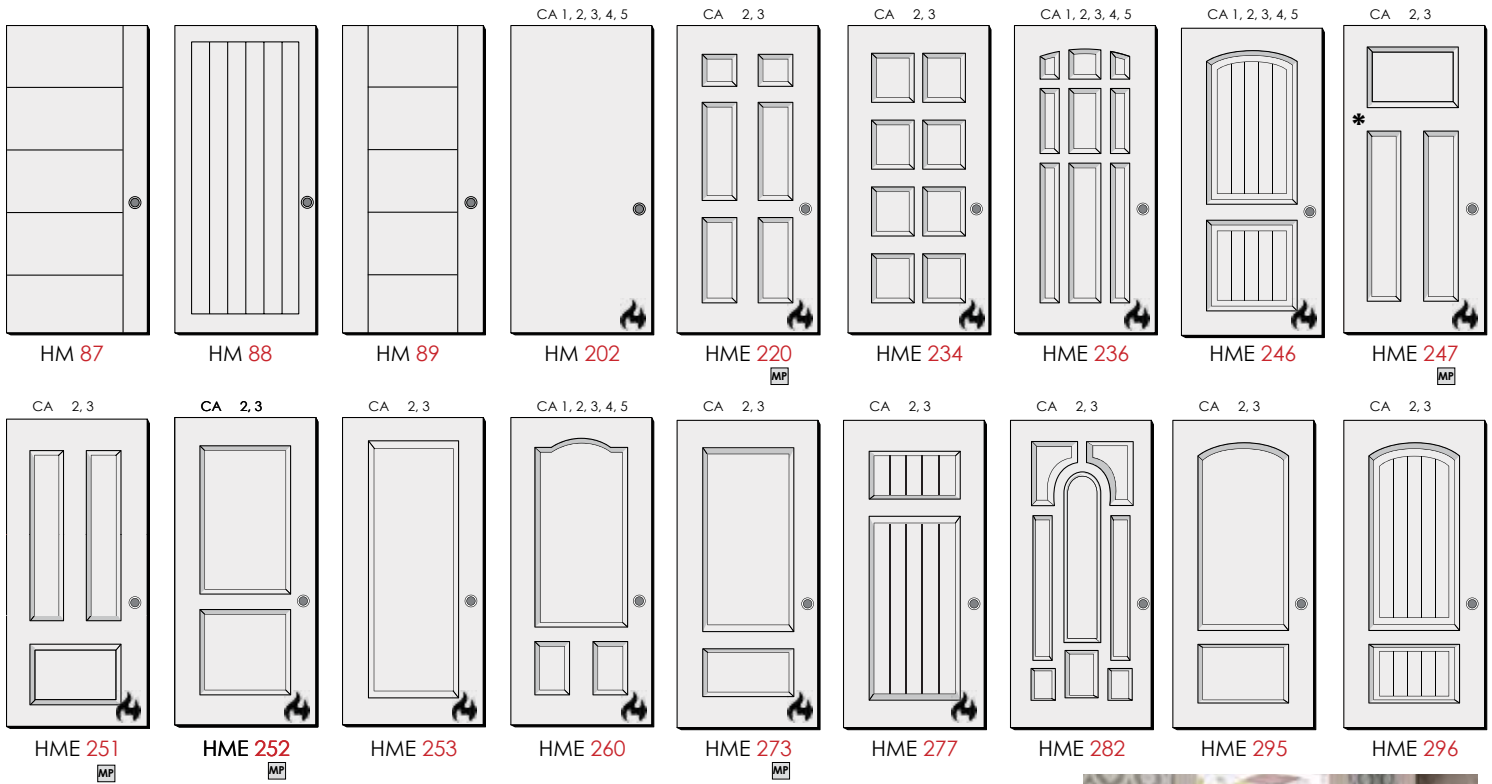

SIDELITES

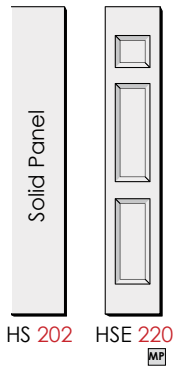

OPTIONS
 [MP] Available with ModaPanels
 🔥 Available in Fire Rated

CUSTOM ARCH TOP STYLES
 CA 1 CA 2 CA 3 CA 4 CA 5

VENTLITES



HM 200 Series Door Styles

	87	88	89	202	220	234	236	246	247	251	252	253	260	273	282	295 296	202	220
--	----	----	----	-----	-----	-----	-----	-----	-----	-----	-----	-----	-----	-----	-----	------------	-----	-----

Price Book Page

	38	38	38	26	43	56	30	50	68	68	52	68	54	58	30	65	71	71
--	----	----	----	----	----	----	----	----	----	----	----	----	----	----	----	----	----	----

Steel Max Height

Smooth Steel 20GU				96"	96"	84"	84"	84"	84"	90"	84"	84"	84"	84"			96"	96"
Textured Steel 20GU				96"	96"	84"	84"	84"	84"	90"	84"	84"	84"	84"			96"	96"

Fiberglass Max Height

Regency & Aspen Oak				84"	84"		80"				80"		84"	84"	84"		84"	
Regency & Aspen Cherry	84"	84"	84"	84"	84"								84"	84"	84"	84"	96"	84"
Regency & Aspen Mahogany					84"								84"					
Regency & Aspen Smooth	84"	84"	84"	84"	80"									84"				
Speak Easy	•	•	•	•							•	•	•	•		•		
Fire Rated Steel Only				•	•	•	•	•	•	•	•	•	•	•				
Bullet Resistant Steel Only				•	•			•			•		•	•				

HM 300 SERIES - EXTERNAL GRIDS



SIDELITES



TRANSOM

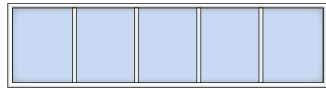

HT 300 / Rectangular pg. 87

OPTIONS

- e Available in Low-E Glass
- MP Also Available with Mod Panels



* Optional Dentil Shelf



HM 300 Series Door Styles	301	305	307	313	317	321	323	325	327	329	331	349-3L	349-6L	376	385-3L	385-6L	386-3L	386-6L	387-3L	387-6L	300	323	327	329	386
Price Book Page	42	43	43	45	47	48	51	53	57	33	33	68	59	70	66	69	71	77	79	73	80				
Steel Max Height																									
Smooth Steel 20GU	96"	96"	96"	96"	96"	96"	84"	84"	96"	96"	96"	84"	84"	84"			84"	84"			84"	96"	96"	96"	96"
Textured Steel 20GU	96"	96"	96"	96"	96"	96"	84"	84"	84"	96"	96"	84"	84"	84"			84"	84"			84"	96"	84"	96"	96"
Fiberglass Max Height																									
Regency & Aspen Oak	80"	84"	84"	84"	80"		80"	80"	84"	84"	84"			84"	84"							84"	84"	84"	
Regency & Aspen Cherry		84"	84"	84"					84"	84"	84"			84"	84"							84"	84"	96"	
Regency & Aspen Mahogany		84"	84"	84"					84"	84"	84"											84"	84"	84"	
Regency & Aspen Fir																		84"							84"
Regency & Aspen Smooth	80"	80"	80"	80"	80"	80"			80"	84"	84"			84"			84"					80"	84"	84"	
Micro-Granite - MG	•											•		•	•	•									•
Rain - RN	•			•	•	•						•		•	•	•						•			•
Streamed - STM												3L		3L							3L				
Pebbled Film - PB		•	•																						

HM 400 SERIES - INTERNAL GRIDS

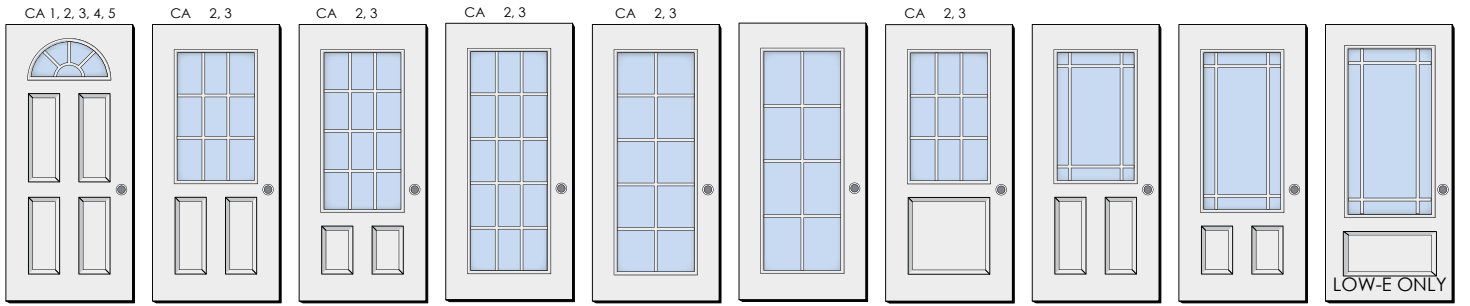

HME 401 eMP HME 403 eMP HME 407 eMP HM 409 e HM 411 e HM 415 e HME 417 eMP HME 419 MP HME 421 eMP HME 422 eMP

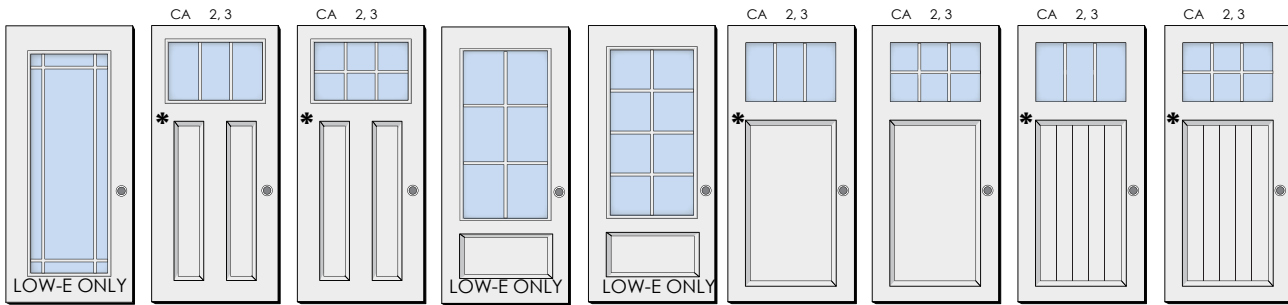

HM 423 e HME 449-3L eMP HME 449-6L eMP HME 475 MP HME 477 MP HME 485-3L MP HME 485-6L MP HME 487-3L MP HME 487-6L MP

Vent Lites (White Glass Trim Only)

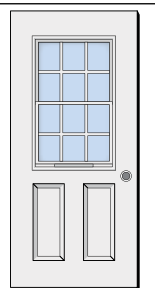

HME 427 eMP

TRANSOMS

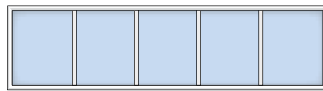

HT 400 / Rectangular pg. 88

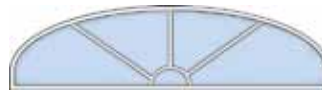

HT 430 / Elliptical pg. 94

SIDELITES

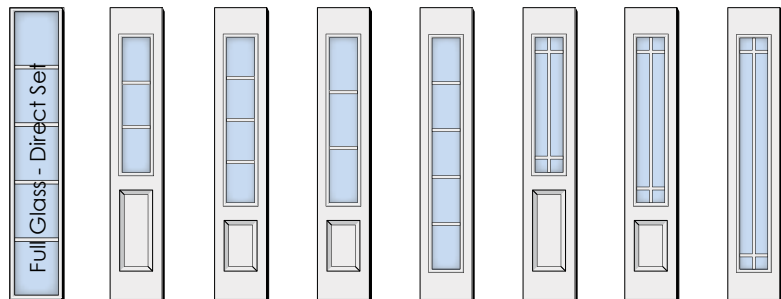

HS 400 HSE 401 eMP HSE 405 eMP HSE 406 MP HS 407 e HSE 419 eMP HSE 421 eMP HS 423 e

ALUMINUM ROLL FORMED INTERNAL GRIDS

Thermally sealed between two pieces of tempered glass, Internal Grids provide the same classic beauty as external grids, but with the added advantage of easy-to-clean glass.

5/8" x 1/4"

White STD



HM 400 Series Door Styles	401	403	407	409	411	415	417	419	421	422	423	427	449-3L 449-6L	475 477	485-3L 485-6L	487-3L 487-6L	400	401	405	406	407	419	421	423	
Price Book Page	42	45	57	33	33	33	53	45	57	59	33	45	68	59	70	69	71	77	77	79	73	77	79	73	
Steel Max Height																									
Smooth Steel 20GU	96"	96"	96"	96"	96"	96"	84"	96"					96"	84"		84"	84"	96"	96"	96"	96"	96"	96"	96"	96"
Textured Steel 20GU	96"	96"	84"	96"	96"	96"	84"	96"					96"	84"		84"	84"	96"	96"	84"	84"	96"	96"	84"	96"
Fiberglass Max Height																									
Regency & Aspen Oak	80"	84"	84"	84"	84"	84"	80"	80"	84"				84"			84"		84"	84"	84"	84"	84"	84"	84"	84"
Regency & Aspen Cherry		84"	84"	84"	84"	84"		84"					84"			84"		84"	84"	84"	96"	84"	84"	96"	
Regency & Aspen Mahogany		84"	84"	84"	84"	84"		84"					84"			84"		84"	84"	84"	84"	84"	84"	84"	84"
Regency & Aspen Smooth	80"	80"	80"	84"	84"	84"		80"	80"	84"	84"							80"	80"	84"	84"	80"	80"	84"	
Rain - RN																									

HM 500 SERIES - INTERNAL STEEL GRIDS MATCH DOOR COLOR



SIDELITES



*  Optional Dentil Shelf

TRANSOMS

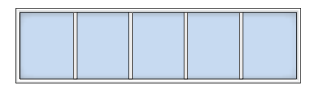

HT 500 / Rectangular pg. 88

Thermally sealed between two pieces of tempered glass.

- Custom sizes available
- Match any entry door color in & out
- 3/4 Flat steel bar for added security
- Aluminum moda door trim (pg. 13)

HM 500 Series Door Styles	501	503	507	509	511	513	515	517	519	522	549-3L 549-6L	575 576	585-3L 585-6L	586-3L 586-6L	587-3L 587-6L
---------------------------	-----	-----	-----	-----	-----	-----	-----	-----	-----	-----	------------------	------------	------------------	------------------	------------------

Price Book Page	42	45	57	33	33	33	33	53	45	59	68	59	70	66	69
Steel Max Height															
Smooth Steel 20GU	96"	96"	96"	96"	96"	96"	96"	84"			84"	84"	84"		84"
Textured Steel 20GU	96"	96"	84"	96"	96"	96"	96"	84"			84"	84"	84"		84"
Fiberglass Max Height															
Regency & Aspen Oak	80"	84"	84"	84"	84"	84"	84"	80"					84"	84"	
Regency & Aspen Cherry		84"	84"	84"	84"	84"	84"						84"	84"	
Regency & Cherry Mahogany		84"	84"	84"	84"	84"	84"								
Regency & Aspen Fir											84"			84"	
Regency & Aspen Smooth	80"	80"	80"	84"	84"	84"	84"	80"	84"					84"	
Micro-Granite - MG	•	•	•	•	•			•			•	•	•	•	•

3/4" x 1/4" STEEL INTERNAL GRIDS

Also available in Micro-Granite



Stain

Privacy Level - 9



Micro-Granite - MG (Old Pebbled)

INTERNAL MINI BLINDS

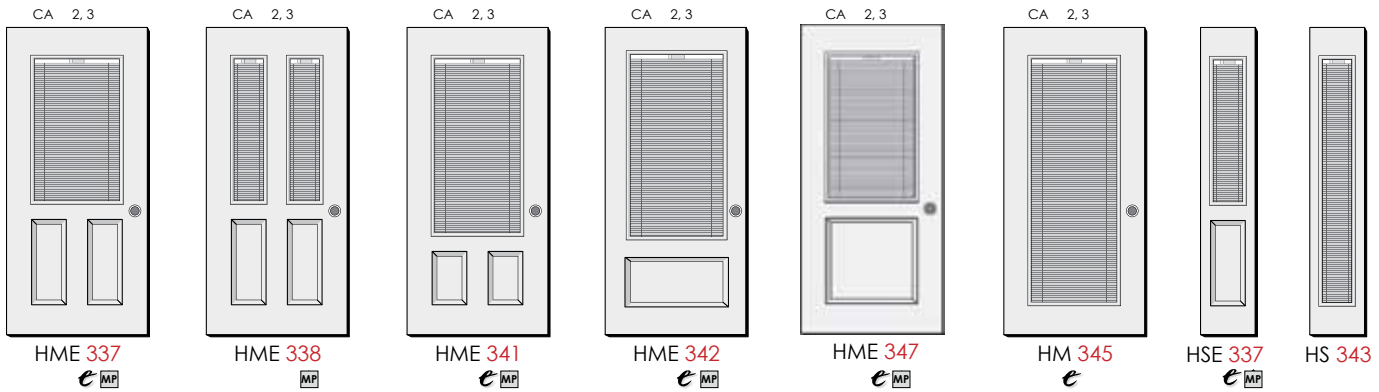

Thermally sealed between two pieces of tempered glass, Internal Blinds (raise, lower and tilt) combine the privacy and light control of conventional blinds, with a hassle-free internal design requiring no dusting at all.

Note: There is a 1/4" gap between the edge of the blind - left, right and bottom - and the glass trim. This ensures proper operation when raising and lowering the blinds.



Espresso



Silver Moon



Sand



Slate Gray

INTERNAL MINI BLINDS WITH INTERNAL GRIDS

WHITE ONLY

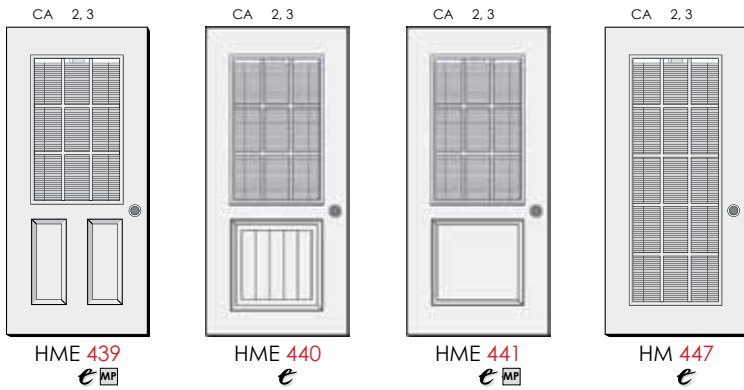

OPTIONS

- Available in Low-E Glass
- Available with Moda Panels



HM 447 Door in a Patio Configuration ▲

Mini Blinds Door Styles												
Price Book Page	45	48	57	32	53	45	51	53	33	77	73	
Steel Max Height												
Smooth Steel 20GU	96"	84"	96"	96"	84"	96"	84"	84"	96"	96"	96"	
Textured Steel 20GU	96"	84"	84"	96"	84"	96"	84"	84"	96"	96"	96"	
Fiberglass Max Height												
Regency & Aspen Oak	84"		84"	84"	80"	84"	80"	80"	84"	84"	84"	
Regency & Aspen Cherry	84"		84"	84"		84"			84"	84"	84"	
Regency & Aspen Mahogany	84"		84"	84"		84"			84"	84"	84"	
Regency & Aspen Smooth	80"	80"	80"	84"					84"	80"	84"	

CUSTOM DOOR CONFIGURATIONS

Patio Door (with Single or No Screen)

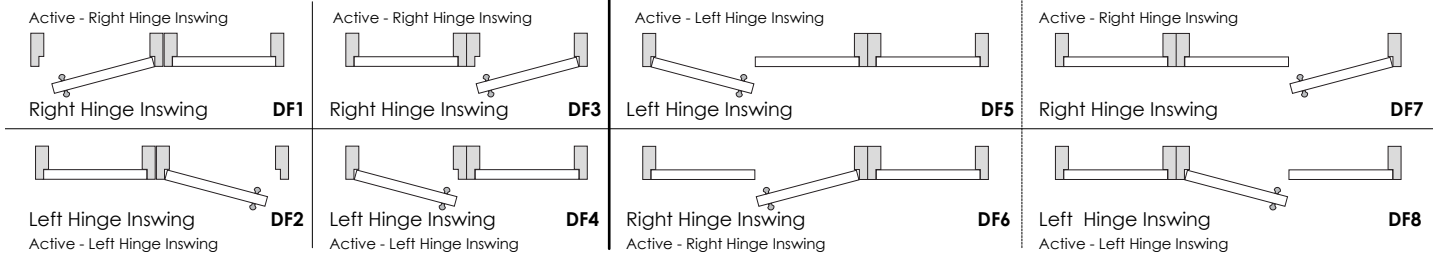

Double Door and One Stationary Door or Sidelite Unit (with Double or No Screen)

Triple Patio Unit (with Single or No Screen)

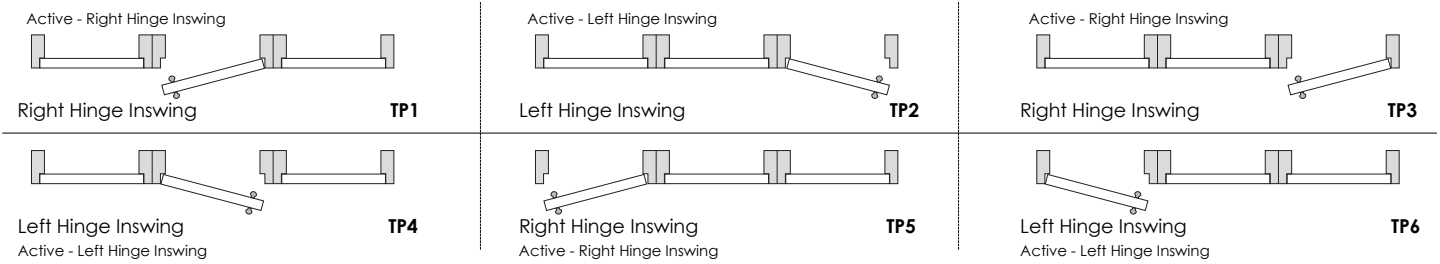

Double Door and Two Stationary Doors or Sidelites Unit (with Double or No Screen)

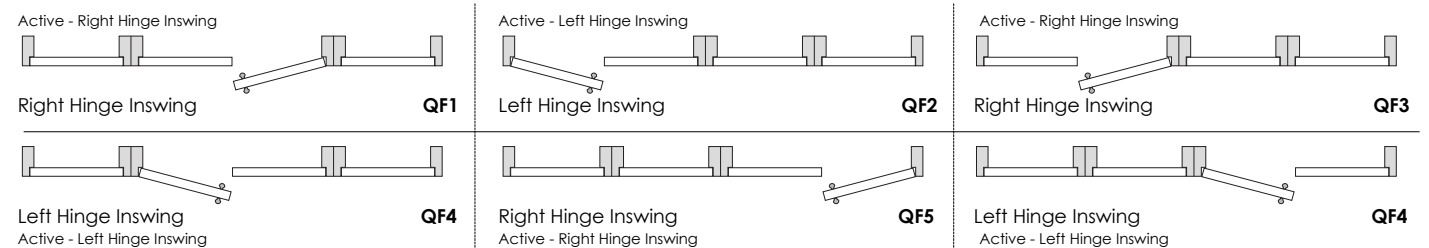

HANGING SLIDING SCREEN

For New Construction Only, Not Replacement

Exclusively manufactured by HMI, our Sliding Screen Door features a unique aluminum extruded design ensuring highest quality construction and durability. Unlike other sliding screens where all the weight is placed upon a floor mounted track, HMI's design uses a dual-wheel hung design allowing for a smooth and stress-free operation. (White is STD. Color is optional)

Single Sliding Screen configuration used for patio doors and Dual Sliding Screen configuration used for double doors. (Illustrated to the right)

Screen Location

Inswing Patio and Double Door, screens are on the outside of the house. Outswing Patio and Double Doors, screens are on the inside of the house.



FIRE RATED / BULLET RESISTANT DOOR PANEL STYLES

Fire Rated

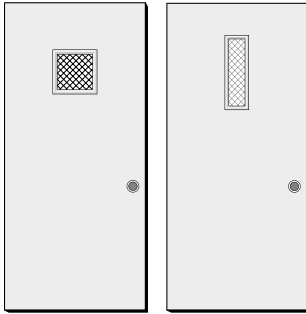

HM 433W

HM 435W

Max Size 36 x 84
Smooth or textured steel only

See pg. 60 for more door styles

Price Book Page 15

Bullet Resistant Door Panels

Outside of door will have embossments
Inside of the door will be FLUSH

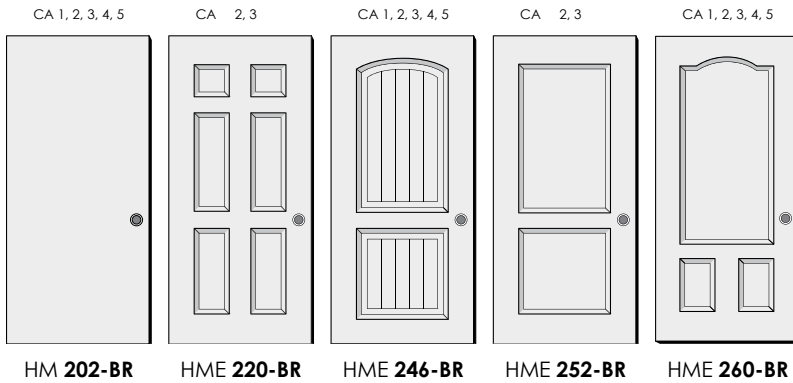

HM 202-BR

HME 220-BR

HME 246-BR

HME 252-BR

HME 260-BR

A Level 3 bullet resistant door panel does not have to look like battle armor. Our bullet resistant door panels are available in steel or fiberglass and can be painted or stained. No one but you will know that the door is bullet resistant.

These door panels are rated: NIJ-STD-0108.01 Level IIIA Bullet Resistant; and ANSI/UL-752 Level 3 Bullet Resistant. This combined with our 3 point mortise lock and hinge side ArmorMax™ jamb make our bullet resistant door panels the most secure residential doors on the market.

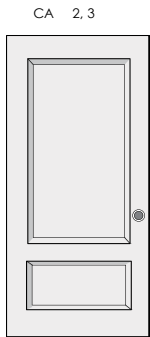

HME 273-BR

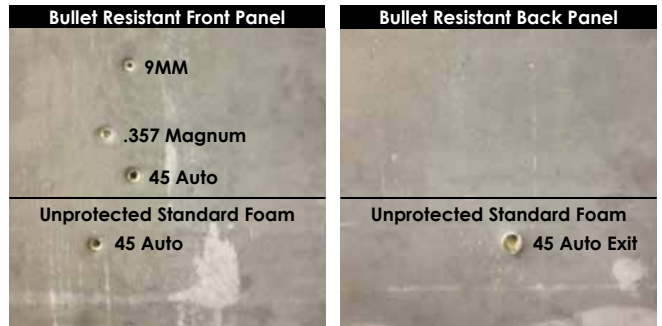
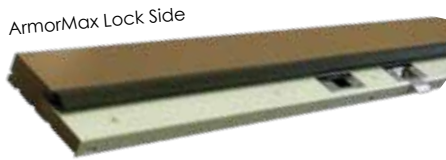

Max Size 36 x 84						
Price Book Page	25	25	25	25	25	25
Steel						
Smooth Steel 20GU	84"	84"	84"	84"	84"	84"
Textured Steel 20GU	84"	84"	84"	84"	84"	84"

Sold only with 3-Point Lock System. See pg. 70 for additional details and handle selections.



FRENCH SIDELITES AND QUICKSHIP



French Sidelites work just like our Double Doors, another innovative option by HMI.

Hinged on opposite sides of the jamb, French Sidelites allow for the sidelite and door to be opened simultaneously, providing a wider opening.

Enjoy the beauty of a classic door and sidelite with the practical space to move household appliances and furniture through.

◀ HM 242N Door and HS 242N Sidelite ▶



HMI QUICK SHIP DOORS

Available in 5 business days or less – Quick ship doors are constructed of smooth 20 gauge steel; painted white; can be either inswing or outswing; are available with a steel replacement frame or 4 9/16" new construction jamb; have clear glass; and polished hinges standard (other hardware finishes are optional). Available sizes are listed below each style Quick Ship door.

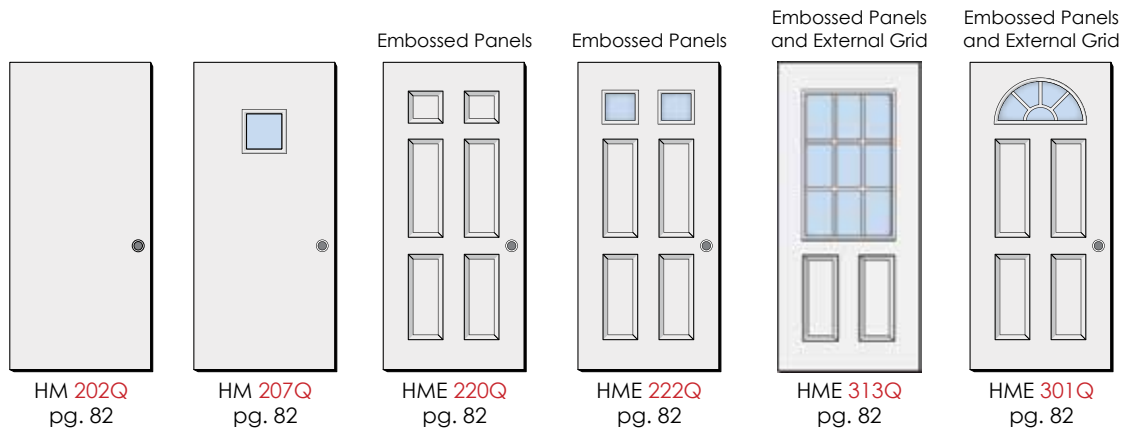

REPLACEMENT	202	207	220	222	313	301
28 X 80	X	X	N/A	N/A	N/A	N/A
30 X 80	X	X	X	X	X	X
32 X 80	X	X	X	X	X	X
36 X 80	X	X	X	X	X	X

NEW CONSTRUCTION	UNIT FINISH					
	29-1/2 X 81-1/2	29-1/2 X 81-1/2	N/A	N/A	N/A	N/A
28 X 80	N/A	31-1/2 X 81-1/2	31-1/2 X 81-1/2	31-1/2 X 81-1/2	31-1/2 X 81-1/2	31-1/2 X 81-1/2
30 X 80	N/A	33-1/2 X 81-1/2	33-1/2 X 81-1/2	33-1/2 X 81-1/2	33-1/2 X 81-1/2	33-1/2 X 81-1/2
32 X 80	N/A	37-1/2 X 81-1/2	37-1/2 X 81-1/2	37-1/2 X 81-1/2	37-1/2 X 81-1/2	37-1/2 X 81-1/2

HARDWARE



Polished Brass



Antique Brass



Satin Nickel

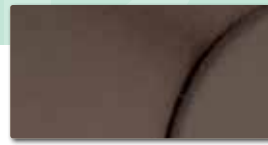

Aged Bronze

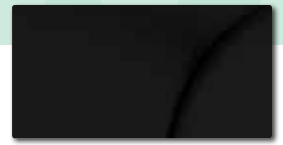

Black

PREMIUM HANDLE SETS BY SCHLAGE

Please refer to each lock for specific finish availability.



Addison #24



Plymouth #25



Interior Georgian Knob #17



Interior Accent Lever #18

Interior options for handle sets are the Georgian Knob or the Accent Lever. A Single Cylinder Deadbolt is standard with entry handle sets.

HMI offers four different hardware finish options:

- Polished Brass
- Satin Nickel
- Antique Brass
- Aged Bronze
- Black



Single Cylinder w/ Century Trim



Latitude w/ Century Trim #16



Bowery w/ Century Trim #15

Camelot #26

Standard Handle Sets By Schlage



Exterior



Exterior



Exterior



Interior



Interior



Interior

Georgian Keyed Knob #19

Accent Keyed Lever #21

Keyed Exterior Knob with Interior Lever #20

Deadbolt Options



Double Cylinder - Keyed Exterior & Interior



Single Cylinder - Keyed Exterior & Thumb Turn Interior

Accessories



Mail Slot - (3 x 10)
Magazine Mail Slot - (3 1/2 x 13)

US Postal regulations require mail slots to be no less than 30" from the ground.

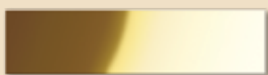

Magnetic Kick Plate



Peepsite



Peek-O Viewer



Knocker



Peep Knocker



Decor Pitcher Handle

#5 LOCK



Exterior



Single Cylinder #5



Interior



Double Cylinder #5

DISTINCTIVE HANDLE SETS BY EMTEK

WITH TUBULAR BACKSETS



Ribbon & Reed #30



Marietta #32



Wilshire #34

Interior Handle Options #30, #32, #34



Egg Knob



Wembley Lever



Cortina Lever



Milano Lever



Mortise Lock: The ideal solution for narrow doors with large glass.

Mortise Lock #36



#59 #57
Decorative Pull Handles
48" Tall

WI-FI KEYPADS

- Enter an access code on a touchscreen
- Unlock door from your phone with the Schlage app
- Add up to 30 user codes
- Easy to add or delete codes



Century Trim #31



Camelot Trim #33

KEYLESS ENTRY BY SCHLAGE



Interior

Digital Single Cylinder
Deadbolt #28

Passage Lever #23

- Available with any Schlage entry hardware
- Lighted keypad
- 9-volt battery included
- Add up to 19 user codes
- Easy to add or delete codes



Optional - Deadbolt



Interior

Digital Accent
Lever #29

3-POINT LOCK



The 3 point lock is the perfect answer for security & bullet resistant doors. The top and bottom deadbolt locations are hidden from outside to prevent the intruder from breaking in.

- The top and bottom 3/4" backsets are passive until the deadbolt is engaged.
- The 1" deadbolt backset is engaged by turning the key on the outside or thumb turn on the inside. When the deadbolt is locked it automatically activates the projections in the top and bottom locks to become a 3 deadbolt locking system.



The lock with the click
Automatic latchbolts
projection from 10 to 20mm

- The stainless steel lock faceplate runs the full length of the door.
- The Allegro, Berkeley and Capri lever handle sets are available in single cylinder. See available finishes under each lock set.

3 Point Lock



Allegro #44
 Polished Brass
 Satin Nickel
 Antique Brass
 Aged Bronze



Capri #45
 Polished Brass
 Satin Nickel
 Antique Brass
 Aged Bronze



Berkeley #47
 Satin Nickel
 Aged Bronze

PAINT, POWDERCOAT AND STAINS

Paint / Powdercoat



Stain Finishes

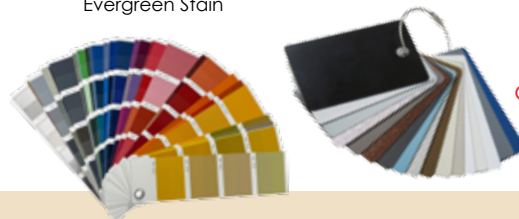

We can also paint your door a custom color with a color sample

Note: These sample colors do not accurately reflect actual painted/stained or powdercoated surface colors due to limitations in the printing process. Please see your sales representative for HMI color chips.

HMI steel entry doors are 20 gauge galvanized to A40 and chem treated to prevent rusting. **HMI** steel and fiberglass doors are first primed with a durable undercoat that is oven-cured for lasting resiliency.

Paint - A final paint finish is applied to the doors and oven-cured a second time forming an enduring lustrous look.

Stain - Hand applied to textured doors to give a wood grain appearance, it is then top coated with a 2-part clear urethane protective coat containing a UV inhibitor. Then it is oven-cured a second time forming an enduring lustrous look.

Powdercoat - Aluminum and security storm doors are chem washed then oven dried. The powdercoating is electrostatically applied and double baked to create a durable resilient finish. Powdercoats have a glossier sheen than do paints. For storm doors within 1 mile of shore line it is recommended to have: security doors zinc plated and aluminum storm doors chromated.

P - Matching Powder Coat finish to match Entry Door colors for Aluminum and Security Storm Doors

X - Paint Finish available on Textured Doors Only - Black

* Due to possible heat buildup, the warranty for entry doors does not apply to the door or glass trim painted in these colors when installed behind storm doors.



BE SURE TO ALSO LOOK AT OUR ALUMINUM & SECURITY STORM CATALOG



Distributed by:

PROUDLY MADE IN THE U.S.A.



www.hmidoors.com
Copyright © 2023 Household Metals, Inc.